

# **Iowa Construction Site Erosion Control Manual**

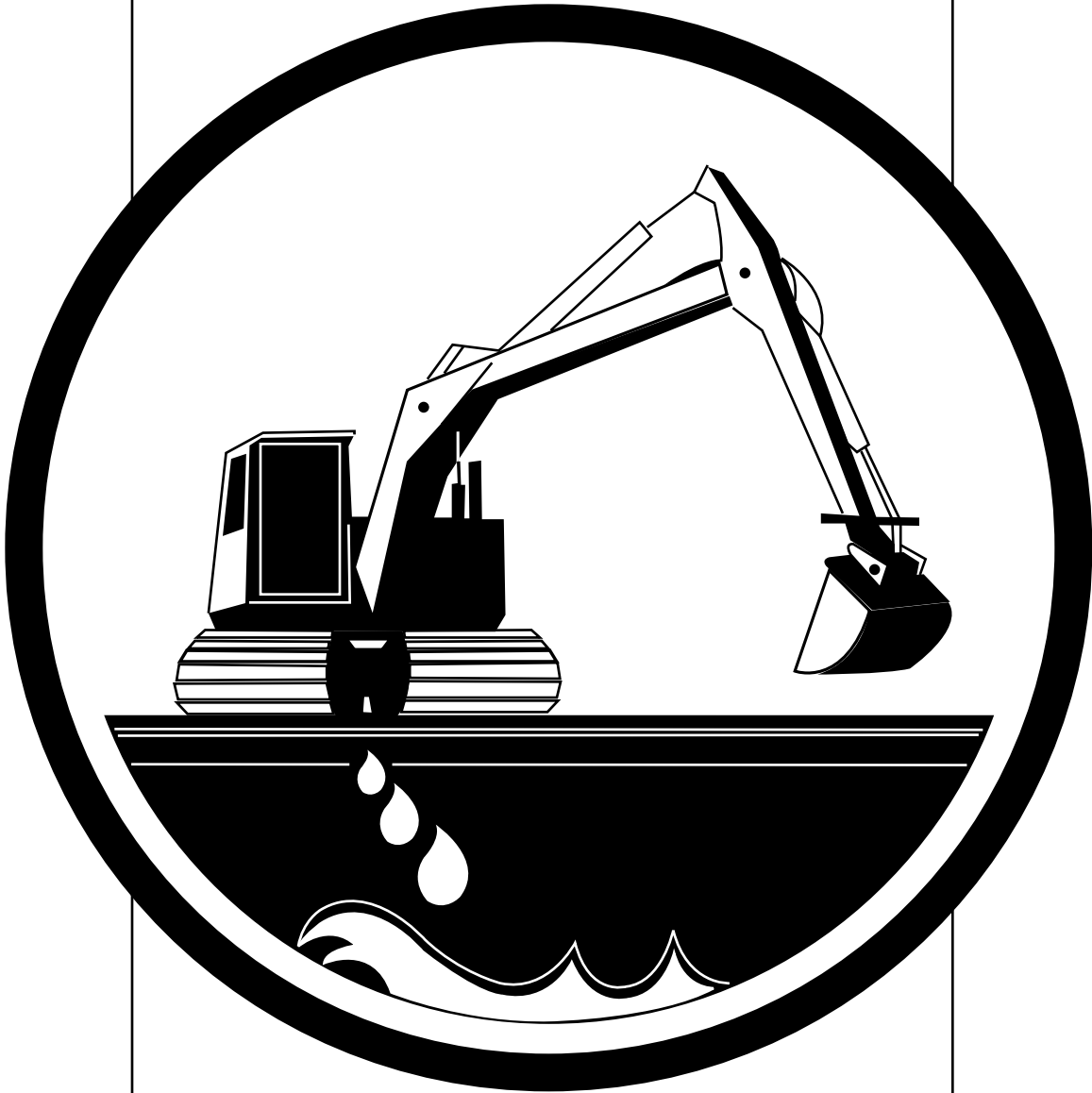

**UPDATED 2006**

**Sponsored by the  
Iowa Department of Natural Resources**

## **DISCLAIMER**

This document is issued in support of federal, state, and local regulations and policies involving storm water runoff and soil erosion legislation. This document is for guidance only. Agency decisions in any case will be made by applying the laws and regulations on the basis of specific facts when permits are issued or regulations promulgated. Mention of trade names or commercial products does not constitute endorsement or recommendation for use.

# TABLE OF CONTENTS

LIST OF FIGURES .....	III
LIST OF TABLES .....	VI
PREFACE.....	VII
ACKNOWLEDGMENTS .....	VIII
CHAPTER 1. INTRODUCTION.....	1
1.1 Erosion Control .....	1
1.2 Regulatory Requirements .....	5
1.3 Soil Erosion and Sediment Control Measures Matrix .....	9
1.4 Erosion and Sediment Control Plan Preparation .....	13
1.5 Sample Site Plans.....	18
1.6 Implementation Guidelines.....	26
CHAPTER 2. VEGETATION AND SOIL STABILIZATION CONTROL MEASURES .....	39
2.1 Grass Channels .....	39
2.2 Dust Control .....	43
2.3 Mulching .....	45
2.4 Seeding and Fertilizing.....	47
2.5 Silt Fence .....	50
2.6 Sodding .....	55
2.7 Surface Roughening .....	60
2.8 Vegetative Filter Strip.....	61
2.9 Compost Blankets .....	63
2.10 Compost Filter Tubes.....	64
2.11 Rolled Erosion Control Products.....	66
2.12 Wattles .....	70
2.13 Flocculents .....	72
2.14 Turf Reinforcement Mats.....	73
CHAPTER 3. STRUCTURAL EROSION CONTROL MEASURES .....	75
3.1 Bench .....	75
3.2 Compost Filter Berms .....	77
3.3 Check Dam .....	80
3.4 Temporary Slope Drain (Pipe or Rock).....	82
3.5 Energy Dissipator.....	83
3.6 Flotation Silt Curtain.....	84
3.7 Rock Chutes and Flumes.....	86
3.8 Gabion.....	87
3.9 Inlet Protection .....	88
3.10 Jetties.....	96
3.11 Level Spreader.....	98
3.12 Rock Outlet Protection .....	99
3.13 Retaining Wall .....	100
3.14 Stabilized Construction Entrance.....	101
3.15 Riprap.....	102

**Table of Contents**

---

3.16 Sediment Barrier ..... 104  
3.17 Sediment Basin ..... 105  
3.18 Streambank Protection..... 107  
3.19 Stream Channel Enhancement ..... 109  
3.20 Subsurface Drainage ..... 111  
3.21 Diversion Structure..... 113

CHAPTER 4. SPECIAL CONDITION EROSION CONTROL MEASURES ..... 115

4.1 Infiltration Basin and Trench ..... 115  
4.2 Retention Pond ..... 116  
4.3 Serrated Cut..... 118  
4.4 Temporary Stream Crossing ..... 119  
4.5 Wetlands ..... 121

REFERENCES ..... 123

GLOSSARY ..... 126

# LIST OF FIGURES

Figure 1.1. Erosion process (Source: photogallery.nrcs.usda.gov) .....	2
Figure 1.2. Data collection worksheet .....	22
Figure 1.3. Data analysis worksheet .....	23
Figure 1.4. Site plan development worksheet .....	24
Figure 1.5. Erosion and sediment control plan.....	25
Figure 1.6. Vegetative and soil stabilization erosion control measures .....	28
Figure 1.7. Structural erosion control measures .....	29
Figure 1.8. Structural sediment control measures.....	30
Figure 1.9. Intercepting and diverting runoff (Source: Iowa DOT) .....	33
Figure 1.10. Diversion structure (Source: Virginia Department of Conservation & Recreation) ...	33
Figure 1.11. Diversion dike and swale combination (Source: ISU/CCEE).....	34
Figure 2.1. Stream channel (Source: Department of Civil, Construction, and Environmental Engineering, Iowa State University).....	39
Figure 2.2. Waterway cross section (Source: Omaha Soil Erosion Manual) .....	40
Figure 2.3. Waterway (Source: Department of Civil, Construction, and Environmental Engineering, Iowa State University).....	41
Figure 2.4. Special ditch control (Source: Department of Civil, Construction, and Environmental Engineering, Iowa State University).....	42
Figure 2.5. Truck-mounted dust-control applicator (Source: <a href="http://soiltac.com/Photo_Gallery.html">http://soiltac.com/Photo_Gallery.html</a> ) .....	43
Figure 2.6. Manual dust-control applicator (Source: <a href="http://soiltac.com/Photo_Gallery.html">http://soiltac.com/Photo_Gallery.html</a> ) .....	44
Figure 2.7. Mulching (Source: <a href="http://www.usda.gov/stream_restorationnewgra.html">www.usda.gov/stream_restorationnewgra.html</a> ).....	45
Figure 2.8. Seeding and fertilizing (Source: Iowa DOT).....	47
Figure 2.9. Grain drill seeding (Source: Department of Civil, Construction, and Environmental Engineering, Iowa State University).....	47
Figure 2.10. Silt fence (Source: Iowa DOT) .....	50
Figure 2.11. Silt fence situation plan (Source: Department of Civil, Construction, and Environmental Engineering, Iowa State University).....	52
Figure 2.12. Enlargements of number elements in Figure 11 (Source: Department of Civil, Construction, and Environmental Engineering, Iowa State University).....	53
Figure 2.13. Improper silt fence installation (Source: Minnesota DOT) .....	54
Figure 2.14. Proper silt fence installations (Source: Iowa DOT) .....	54
Figure 2.15. Sod truck (Source: Urban Resources and Borderland Alliance Network) .....	55
Figure 2.16. Sod placement in eroded gully and silted ditch (Source: Department of Civil, Construction, and Environmental Engineering, Iowa State University).....	57
Figure 2.17. Sod placement in no-ditch and slope situations (Source: Department of Civil, Construction, and Environmental Engineering, Iowa State University).....	58
Figure 2.18. Sod staking (Source: Department of Civil, Construction, and Environmental Engineering, Iowa State University).....	59
Figure 2.19. Surface roughening by disking (Source: Iowa DOT).....	60
Figure 2.20. Roadway filter strip (Source: Iowa DOT).....	61
Figure 2.21. Vegetative filter strip (Source: photogallery.nrcs.usda.gov).....	62
Figure 2.22. Urban filter strip (Source: Department of Civil, Construction, and Environmental Engineering, Iowa State University).....	62
Figure 2.23. Blown compost blanket (Source: Iowa Natural Resources Conservation Service 2004) .....	63
Figure 2.24. Compost filter tube (Source: SUDAS Design Manual).....	64
Figure 2.25. Backslope protection (Source: Department of Civil, Construction, and Environmental Engineering, Iowa State University).....	66

Figure 2.26. Foreslope protection in growth stage (Source: Department of Civil, Construction, and Environmental Engineering, Iowa State University)..... 66

Figure 2.27. Wood excelsior mat (Source: North American Green)..... 67

Figure 2.28. Coconut fiber roll (Source: Natural Resources Conservation Service)..... 70

Figure 3.1. Bench cut, upper level (Source: Department of Civil, Construction, and Environmental Engineering, Iowa State University)..... 75

Figure 3.2. Bench cut, profile view (Source: Department of Civil, Construction, and Environmental Engineering, Iowa State University)..... 76

Figure 3.3. Bench cut, interchange application (Source: Department of Civil, Construction, and Environmental Engineering, Iowa State University)..... 76

Figure 3.4. Berm (Source: Urban Resources and Borderland Alliance Network)..... 77

Figure 3.5. Temporary berms (Source: West Virginia DOT)..... 78

Figure 3.6. Temporary berm and temporary slope drain system (Source: Department of Civil, Construction, and Environmental Engineering, Iowa State University)..... 79

Figure 3.7. Check Dam (Source: Department of Civil, Construction, and Environmental Engineering, Iowa State University)..... 80

Figure 3.8. Spacing between check dams (Source: Department of Civil, Construction, and Environmental Engineering, Iowa State University)..... 81

Figure 3.9. Temporary slope drain (Source: Department of Civil, Construction, and Environmental Engineering, Iowa State University)..... 82

Figure 3.10. Energy dissipator (Source: Iowa DOT)..... 83

Figure 3.11. Flotation silt curtain (Source: Minnesota DOT)..... 84

Figure 3.12. Flume (Source: Urban Resources and Borderland Alliance Network)..... 86

Figure 3.13. Gabion (Source: Modular Gabion Designs)..... 87

Figure 3.14. Inlet protection (Source: Minnesota DOT)..... 88

Figure 3.15. Inlet protection diagram (Source: Department of Civil, Construction, and Environmental Engineering, Iowa State University)..... 90

Figure 3.16. Inlet sediment control (Source: Department of Civil, Construction, and Environmental Engineering, Iowa State University)..... 91

Figure 3.17. Filter fabric drop inlet protection (Source: Department of Civil, Construction, and Environmental Engineering, Iowa State University)..... 91

Figure 3.18. Sod drop inlet protection (Source: Department of Civil, Construction, and Environmental Engineering, Iowa State University)..... 93

Figure 3.19. Curb gutter inlet protection (Source: Department of Civil, Construction, and Environmental Engineering, Iowa State University)..... 94

Figure 3.20. Excavated drop inlet protection (Source: Department of Civil, Construction, and Environmental Engineering, Iowa State University)..... 95

Figure 3.21. Jetty (Source: Department of Civil, Construction, and Environmental Engineering, Iowa State University)..... 96

Figure 3.22. Jetties (Source: Department of Civil, Construction, and Environmental Engineering, Iowa State University)..... 97

Figure 3.23. Level spreader installation (Source: William B. Umstead State Park)..... 98

Figure 3.24. Rock outlet protection (Source: Iowa DOT)..... 99

Figure 3.25. Retaining Wall (Source: Department of Civil, Construction, and Environmental Engineering, Iowa State University)..... 100

Figure 3.26. Temporary stabilized construction entrance to construction site (Source: Department of Civil, Construction, and Environmental Engineering, Iowa State University)..... 101

Figure 3.27. Riprap (Source: Department of Civil, Construction, and Environmental Engineering, Iowa State University)..... 102

Figure 3.28. Use of riprap to protect streambanks and bottoms (Source: Department of Civil, Construction, and Environmental Engineering, Iowa State University)..... 103

Figure 3.29. Silt fence sediment barrier (Source: Department of Civil, Construction, and Environmental Engineering, Iowa State University)..... 104

Figure 3.30. Sediment basin (Source: Department of Civil, Construction, and Environmental Engineering, Iowa State University)..... 105

Figure 3.31. Streambank protection (Source: International Erosion Control Association)..... 107

Figure 3.32. Streambank protection measures (Source: Department of Civil, Construction, and Environmental Engineering, Iowa State University)..... 108

Figure 3.33. Stream channel enhancement (Source: Natural Resources Conservation Service) ..... 109

Figure 3.34. Subsurface drainage (Source: Iowa DOT)..... 111

Figure 3.35. Subsurface drainage patterns (Source: Department of Civil, Construction, and Environmental Engineering, Iowa State University)..... 112

Figure 4.1. Infiltration basin and trench (Source: Department of Civil, Construction, and Environmental Engineering, Iowa State University)..... 115

Figure 4.2. Retention pond (Source: Department of Civil, Construction, and Environmental Engineering, Iowa State University) ..... 116

Figure 4.3. Serrated cut (Source: Department of Civil, Construction, and Environmental Engineering, Iowa State University) ..... 118

Figure 4.4. Temporary stream crossing (Source: F. X. Browne, Inc.)..... 119

Figure 4.5. Temporary bridge for construction equipment access (Source: Department of Civil, Construction, and Environmental Engineering, Iowa State University)..... 119

Figure 4.6. Urban wetlands (Source: Department of Civil, Construction, and Environmental Engineering, Iowa State University) ..... 121

# LIST OF TABLES

---

Table 1.1. Soil textural classes and general terminology used in soil descriptions (Source: US Environmental Protection Agency 1977).....	5
Table 1.2. Requirements in General Permit No. 2 related to erosion and sediment control.....	7
Table 1.3. Vegetation and soil stabilization erosion control measures .....	10
Table 1.4. Structural erosion control measures.....	11
Table 1.5. Special conditions erosion control measures.....	12
Table 1.6. Classification of vegetal cover in waterways based on degree of flow retardance by vegetation (Source: U.S. EPA 1976).....	31
Table 1.7. Grass establishment alternatives (Source: VSWCC 1980).....	31
Table 1.8. Maximum flow velocities (Source: USDA, SCS 1979b) .....	32
Table 1.9. Waterway linings in order of increasing flow velocity and handling capacity .....	36
Table 1.10. Maximum permissible design velocities for stable grass-lined channels (Source: USDA, SCS 1975).....	37
Table 1.11. Permissible velocities for earth-lined channels (Source: Soil & Water Conservation Engineering, Schwab et al., & American Society of Civil Engineers).....	38
Table 2.1. Dust control methods—dilution and rates of application .....	43
Table 2.2. Silt fence spacing on slopes .....	50
Table 2.3. Silt fence spacing in ditches .....	51
Table 2.4. Compost blanket thickness on slopes .....	63
Table 2.5. Maximum compost tube spacing .....	64
Table 2.6. Typical rolled erosion control product properties and uses* (Source: Lancaster & Austin 2004) .....	68
Table 2.7. Recommended wattle spacing by slope.....	70
Table 3.1. Maximum filter berm spacing for berm size of 1' x 2' (height x width).....	77
Table 3.2. Size of riprap stones.....	103
Table 3.3. Diversion structure slopes by soil type (Source: Smoot 1999).....	114



# PREFACE

---

The purpose of this Iowa manual is to serve as a guide, provide solutions, and offer suggestions on construction sites to comply with Iowa's current soil erosion and storm water runoff regulations. This need is particularly important when land undergoes a land use change. Information provided in this manual will be helpful to land owners, developers, consultants, contractors, planners, local government, as well as the general public.

This manual is intended to provide techniques that will meet the mandates of current legislation. Innovations that will benefit the user and still provide effective control are encouraged.

As an undeveloped area is changed to urban, commercial, or industrial use, natural cover is removed and the chance of erosion problems increases. Natural drainage areas are usually changed to remove runoff rapidly. In addition, paved streets, sidewalks, buildings, and compacted soil add to the runoff. Runoff from snow or rain in these developed areas often washes pollutants off the land and surface areas. These contaminants often contain salt, fertilizer, heavy metals, organic chemicals, pet waste, and sediment from construction sites.

Controlling erosion and water quality and developing procedures to manage construction sites to reduce off-site water pollution is a major concern. The Iowa Department of Agriculture and Land Stewardship, Division of Soil Conservation; the United States Department of Agriculture, Natural Resources Conservation Service; and the Iowa Department of Natural Resources, Environmental Protection Division are all agencies concerned with erosion and sedimentation problems that are present today. These agencies are engaged in technical programs that will reduce erosion and save our soil.

This manual has been authorized and funded by the Iowa Department of Natural Resources (IDNR).

# ACKNOWLEDGMENTS

---

Thanks to the following organizations for their input in this research:

Associated Builders and Contractors, Inc.  
Associated General Contractors of Iowa  
Beal Development Corporation  
City of Cedar Rapids  
City of Des Moines  
Conservation Districts of Iowa  
Extension Agronomy  
Harold Dolling  
Harold Dolling & Associates  
Home Builders Association  
Iowa Association of Counties  
Iowa Association of Realtors  
Iowa Chapter of American Society of Landscape Architects  
Iowa County Engineers Association  
Iowa Department of Agriculture and Land Stewardship, Division of Soil Conservation  
Iowa Department of Natural Resources, Environmental Services Division  
Iowa League of Municipalities  
Iowa State University Agricultural Education & Studies Department  
Iowa State University Extension  
Land Improvement Contractors Association  
Master Builders of Iowa  
Office of Road Design - Iowa Department of Transportation  
U.S.D.A. Natural Resources Conservation Service

Information for the preparation of this manual has been drawn from many sources. They include members of the original Iowa Erosion Control Task Force and numerous companies and associations which include the following:

Advanced Drainage Systems, Inc.  
American Excelsior Company, Photos  
American Institute of Certified Planners  
American Public Works Association  
American Public Works Association, Iowa Chapter  
American Society of Agronomy  
American Society of Civil Engineers  
Anderson-Bogert  
Applied Ecological Services, Inc.  
Armorform Inc.  
Armortec™ Erosion Control Solutions  
A.S.P. Enterprises, Inc.  
Association of Builders and Contractors  
Associated General Contractors of Iowa

BBA Nonwovens  
Belton Industries, Inc.  
Black Hawk County  
Black Hawk Soil & Water Conservation District  
Brain Engineering Company  
Carpenter Erosion Control  
Cedar Rapids Chapter of Iowa Engineering Society  
Cedar Rapids Erosion Control Committee  
Cedar Rapids Home Builders Association  
Cedar Rapids/Iowa City Architects Council  
Cedar Rapids/Marion Board of Realtors  
Cedar Rapids/Marion Homebuilders Association  
Cedar Rapids Skogman Homes  
Center for Industrial Research and Service  
Center for Portland Cement Concrete Pavement Technology  
Center for Transportation Research and Education  
Central Fiber Corporation  
Chamness Technology, Inc.  
City of Bettendorf Parks & Recreation  
City of Cedar Falls  
City of Cedar Rapids  
City of Council Bluffs  
City of Des Moines  
City of Hiawatha  
City of Marion  
City of Mason, Ohio Engineering Department  
City of West Des Moines  
Civil Engineering Research Foundation  
CMI Limited Company  
Colloid Environmental Technologies Company  
Conservation Design Forum, Inc.  
Conservation Districts of Iowa (CDI)  
CONTECH Construction Products Inc.  
Des Moines Metro Area Urban Water Quality Project  
Devon Distributing Corporation  
Duluth Technical College, Erosion Control Design  
Easter Lake Park Homeowners Association  
Environmental Barricades Inc.  
Environmental Protection Agency, Miscellaneous Publications  
Erosion Control Technologies  
Erosion Control Technology Council  
Erosion Solutions LLC  
Ernst Conservation Seeds  
Federal Highway Administration.  
Filtrexx Midwest.  
Foresight Products, LLC.  
Forester Communications Inc.  
F. X. Browne, Inc.  
Georgia Department of Transportation  
Geosynthetic Materials Association  
Geosynthetic Research Institute

## Acknowledgments

---

Greater Cedar Rapids/Marion Homebuilders Association  
Great Rivers Chapter – IECA  
Hall & Hall Engineers  
Hild & Associates  
Home Builders Association  
Home Builders Association of Greater Des Moines  
Home Builders Association of Northeast Iowa  
Howard R. Green Company  
Hydro-Solutions, Inc.  
Illinois, Department of Transportation  
Industrial Fabrics Association International  
International Erosion Control Association  
International Geotextile Society  
Invisible Structures, Inc.  
Iowa Highway Research Board  
Iowa Soil and Water Conservation District Commission  
Iowa Association of Counties  
Iowa Association of Municipal Utilities  
Iowa Association of Realtors  
Iowa Chapter of ASLA  
Iowa Concrete Paving Association  
Iowa County Engineers Association  
Iowa Department of Agriculture and Land Stewardship, Division of Soil Conservation  
Iowa Department of Natural Resources  
Iowa Department of Natural Resources, Environmental Protection Division  
Iowa Department of Transportation, Erosion Control Standards  
Iowa Division of Soil Conservation  
Iowa Energy Center, Iowa Department of Natural Resources, City of Des Moines  
Iowa Engineering Society  
Iowa Home Builders Association  
Iowa Land Improvement Contractors Association  
Iowa League of Municipalities  
Iowa State University Engineering and Agronomy Extensions  
Iowa State University Extension Service, Polk County  
Iowa Water Pollution Control Association  
Johnson County Soil & Water Conservation District  
JRM Chemical, Inc.  
Keystone Retaining Walls  
Kirkwood Community College  
League of Iowa Municipalities  
Land Improvement Contractors Association  
Linn County Engineer’s Office  
Linn County Erosion Control Seminar Committee  
Linn County Planning & Zoning Department  
Linn County Soil Conservation Service  
Linn Soil & Water Conservation District  
Master Builders of Iowa  
Mat, Inc.  
Midwestern Culvert, Ltd.  
Minnesota DOT  
Mirafi

Montana, *DOT*  
National Homebuilders Association  
New Jersey, Department of Transportation  
New York, Department of Transportation  
North American Green  
North American Surface Water Quality Conference & Exposition  
Ohio, Department of Transportation  
Partners of Scott County Watersheds  
Pave Tech, Inc.  
Petrattech  
Polk County Conservation Board  
Polk County Soil and Water Conservation District  
Presto Products Company  
Prairie Roots Consulting, Ltd.  
Raccoon River Watershed Project  
Rathje Construction Company  
Raven Industries  
RDG Bussard Dikis, Inc.  
RDG Crose Gardner Shukert Inc.  
Redi-Rock International  
Reemay, Inc.  
Reinforced Earth Company  
RoLanka International, Inc.  
Royal Concrete Pipe, Inc.  
Royal Enterprises America  
Royal Environmental Systems, Inc.  
Royal Erosion Control Systems, LLC  
Scott County  
Shive-Hattery Engineers  
Sierra Club, Central Iowa Chapter  
SI Geosolutions  
Silt-Saver, Inc.  
Snyder & Associates  
Soil Conservation Service  
Soil and Water Conservation Society  
Soil-tek  
Solem Assoc. General Contractors  
Technidea Corporation  
Ten Cate Nicolon  
Tensar Earth Technologies  
Triangular Silt Dike Company, Inc.  
U.S. Army Corps of Engineers  
U.S. Composting Council  
U.S.D.A. Natural Resources Conservation Service  
U.S.D.A. Soil Conservation Service  
U.S. Department of the Interior  
U.S. Environmental Protection Agency  
U.S. Geological Survey  
University of Minnesota.  
University of Wisconsin, Seminar  
Urban Resources and Borderland Alliance Network

## **Acknowledgments**

---

VERSA-LOK Retaining Wall Systems  
Virginia, Department of Transportation  
Waterloo/Cedar Falls Board of Realtors  
William B. Umstead State Park, North Carolina

# CHAPTER 1. INTRODUCTION

---

## 1.1 EROSION CONTROL

The purpose of this manual is to serve as a guide for reducing erosion and preventing sediment from leaving construction sites. In addition, this manual will provide information to contractors, developers, consultants, and planners to help guide them in (1) selecting erosion control practices and (2) preparing plans to reduce erosion on construction sites. Use of this manual is not limited to sites that require a National Pollution Discharge Elimination System (NPDES) permit for storm water discharge. This manual also contains information that a builder can use for building an individual house on a site as well as erosion and sediment control plan recommendations for larger tracts, even if an NPDES permit is not required.

In general, soil erosion is the removal of soil by water, wind, ice, and gravity. This manual deals primarily with soil erosion caused by raindrops. Raindrops strike the soil at a speed of approximately 25-30 feet per second. The impact of the raindrop causes particles of soil to be detached and splash into the air. After the soil particles become dislodged, they can be carried by surface runoff. Surface runoff begins when the soil is saturated and cannot absorb the falling rain. Scouring of the exposed soil by runoff can cause more erosion. As the runoff increases, it tends to be concentrated into rivulets and then into grass channels. As the speed of runoff increases, more soil particles are transported.

The dropping of sediment occurs when the surface flow lessens and the soil particles start to drop. The heavier particles such as gravel and sand settle first, and then the lighter particles settle. Little by little, silt and clay can be transported by rain and finally be carried downstream from its upland point of origin.

Rainfall on unprotected soil causes serious erosion and results in sediment being deposited in waterways and a general degradation of the environment. Public criticism can be very strong when streams are dirty, drainage areas clogged, water supplies threatened, and unsightly deposits of silt occur on the landscape. Certainly, the floods of 1993 demonstrated the power of water and its ability to move silt in staggering volumes.

Removal of soil by water at construction sites that are not protected can result in rills, gullies, sheet erosion, damaged slopes, eroded ditches, plugged drainage structures and culverts, and flooded work areas. Stream channels can be filled with sediment to the point where the flow elevation is raised enough to flood areas adjacent to the stream.

Sediment always damages the areas where it is deposited. For example, sediment buries crops and lawns, kills trees, and fills ditches and other drainage systems. Sediment reduces the storage capacity of reservoirs and fills small ponds and lakes. It also damages aquatic life. Sediment can render an area inadequate for its intended use. Sediment that reaches navigable waterways, such as the Mississippi River, requires the navigation channels to be cleared on a continuous basis.

The information contained in this manual will enable the reader to understand how erosion begins and how various factors affect erosion and sedimentation. This knowledge will then enable the user to apply the best management practices to control erosion and sedimentation.

Erosion and sedimentation are natural processes accelerated by human activities. This manual will therefore provide the user with information to minimize erosion and sediment problems on land undergoing construction activities. Control methods will show how to use plants, water, and soil to improve the quality of the environment.

### Erosion Process

The erosion process is influenced by soil erodibility, climate, vegetative cover, topography, and season. Figure 1.1 illustrates the erosion process.



Figure 1.1. Erosion process (Source: [photogallery.nrcs.usda.gov](http://photogallery.nrcs.usda.gov))

### Soil Erodibility

The soil type determines how vulnerable the soil is to erosion, or its erodibility. Properties determining how easily a soil erodes are texture, structure, organic matter content, and permeability. The most erodible soils generally contain a high percentage of fine sand and silt. The presence of clay or organic material tends to decrease soil erodibility. Clays are sticky and tend to bind soil particles together and resist erosion. But while clays resist erosion, they are easily transported once they have eroded. Well-graded and well-drained gravels are usually the least erodible soils.

### Climate

Rainfall characteristics such as frequency, intensity, and duration directly influence the amount of runoff that occurs. As the frequency of rainfall increases, water has a reduced chance to drain through the soil between storms. When the water cannot drain, the soil will remain saturated for longer periods of time and the volume of storm water runoff may be greater. Erosion risks are high where rainfall is frequent, intense, or lengthy.



## **Vegetative Cover**

Vegetative cover is an extremely important factor in reducing erosion from a construction site. Vegetation protects soil from the forces of raindrop impact and runoff scour. While the top growth shields the soil surface from the raindrop impact, the root mass holds the soil particles in place. Grass buffer strips can be used to filter sediment from surface runoff. Grasses also slow the speed of runoff and help maintain the infiltration capacity of the soil. Establishing and maintaining vegetation can be an effective means for minimizing erosion during development.

## **Topography**

Slope length and steepness influence both the volume and velocity of surface runoff. Long slopes produce more runoff to the bottom of slopes. Steep slopes increase runoff velocity. Both situations increase the potential for erosion.

## **Season**

Temperature has a significant influence on soil erosion. Seasonal variation in temperature and rainfall changes the erosion potential during the year. Frozen soils are relatively erosion-resistant. However, a high erosion potential may exist in the spring when the surface soils first thaw and the ground underneath remains frozen. A low-intensity rain at that time may cause serious erosion because the frozen subsoil prevents water infiltration. Erosion increases during the summer months because of more frequent, intense rains.

## **Types of Erosion**

To deal with water erosion problems effectively, five major types of erosion and their characteristics must be understood so that appropriate control measures can be selected.

### **Raindrop (Splash) Erosion**

When the vegetative cover is destroyed, the soil becomes directly exposed to the impact of raindrops. The soil particles are separated as raindrops strike the bare soil.

The pounding action of the rain destroys the soil structure. As the soil dries, a hard crust often forms. This crust slows plant establishment and reduces water infiltration, thereby increasing future runoff and erosion. Raindrop erosion is related to rain intensity and raindrop size. Some splashed particles may rise as high as 30 inches and move as much as 60 inches horizontally. On a slope, the particles will move down the slope because of gravity.

### **Sheet Erosion**

Erosion caused by water flowing over the soil surface is referred to as sheet erosion. The shallow, moving sheets of water are not usually detaching agents, but the flow of water transports soil particles that have become detached by raindrop impact. The shallow water usually moves as a uniform sheet for only a few feet before concentrating in low spots and other uneven spaces.

## **Rill Erosion**

Rill erosion begins when the shallow sheet flow begins to concentrate in the low areas of the soil surface. When the flow begins to change from sheet flow to a deeper flow in the low areas, the turbulence and velocity of the water increases. This deeper flow now has the energy both to detach and transport soil particles. The small channels cut into the soil surface by this action are called rills. For the most part, rills are only a few inches deep, but are well-defined channels.

The Alutin Rill Erosion Method is a rapid method of measuring rill erosion that is fairly accurate for losses up to 100 tons per acre. The formula for this method is as follows:

The soil loss in tons per acre is equal to the sum in square inches of the cross-sections of rills along a measured lineal distance of 13.7 ft (14 ft) across the slope. For greater accuracy, a 42 ft or 84 ft measurement across the slope can be used, and the sum of the rill measurements can be divided by 3 for 42 ft and 6 for 84 ft.

## **Gully Erosion**

Gullies are formed when runoff cuts rills deeper than ordinary tillage can eliminate. Gullies can become enlarged both up and down the slope. In some soils, a heavy rain can change a rill into a major gully in a very short time. Gullies are difficult to stabilize and costly to control. Erosion loss can be measured by the cross-section method before and after a storm.

## **Channel Erosion**

Channel erosion occurs when the velocity of the flow in a stream is increased or when the bank vegetation is damaged or destroyed. This type of erosion is most common at bends in the stream or where the flow is restricted. Damage may also occur where storm drainage is discharged into the main stream. Eroding streambanks are difficult and expensive to repair. Erosion loss can be measured by the cross-section method before and after a storm.

## **Basic Soils Information—Important for Planning Erosion Control**

Knowing basic soils information is important for planning erosion control measures on any given site. Soil texture is based on the combination of individual particles. Particles are classified on the basis of size and fall into the three categories: sand, silt, or clay. The percent of sand, silt, or clay in a soil sample provides the basis for textural classification, such as silt loam or silty clay loam. Three standard soil textural classifications are used: United States Department of Agriculture (USDA), American Association of State Highway and Transportation Officials (AASHTO), and the Unified Soil Classification System (USCS) as described in ASTM D 2487. The limits of the different textural classes are defined within each of the classification systems. See Table 1.1.

A valuable tool in planning for construction activities is the County Soil Survey. This information is available through the Iowa Soil and Water Conservation District (SWCD) extension offices located in each county and is available on the web at <ftp://pub.gis.iastate.edu/nrcs/ssurgo/>. This survey contains useful information for consultants, planners, engineers, developers, builders, community decision makers, and nearly all other professionals dealing with land use activities.

**Table 1.1. Soil textural classes and general terminology used in soil descriptions (Source: US Environmental Protection Agency 1977).**

Name	Texture	Basic soil textural common class names
Sandy soils	Coarse	Sand Loamy sand
	Moderately coarse	Sandy loam Fine sandy loam
	Medium	Very fine sandy loam Loam Silt loam Silt
	Moderately fine	Clay loam Sandy clay loam Silty clay loam
Clay soils	Fine	Sandy clay Silty clay Clay

## 1.2 REGULATORY REQUIREMENTS

Erosion and sediment control requirements exist at the federal, state, and local levels of government. Some local governments (city and county) have adopted site development or sediment control ordinances or regulations, and it is recommended that contractors or developers check with local units of government to determine whether local ordinances may affect their proposed activities.

### Federal and State Erosion and Sediment Control Requirements

The U.S. Environmental Protection Agency (EPA) issued final regulations on December 8, 1999, identifying which activities or facilities are now required to have storm water permits. Authority to issue the federal NPDES permits within the state of Iowa has been granted to the Iowa Department of Natural Resources (DNR). Thus, compliance with the federal NPDES storm water permit requirements can be achieved by obtaining a permit from the Iowa DNR. The following three topics are discussed in this section:

1. Identify construction projects that need a permit for their storm water discharge
2. Obtaining a permit for storm water discharge for a construction project
3. Determining the erosion and sediment control requirements needed in the NPDES storm water discharge permit

### Construction Projects that Need a Permit for Storm Water Discharge

Effective March 10, 2003, any land-disturbing activity that will “disturb” an area of one or more acres is required to have an NPDES permit for its storm water discharge.

The one-acre limit is based on the “common plan of development.” This common plan of development means that multiple, separate, or distinct construction activities may be taking place

at different times on different schedules under one plan. Thus, breaking down a large project into numerous projects of less than one acre does not relinquish the need for a storm water discharge permit. If the overall common plan of development will involve the disturbance of one or more acres, construction on any portion of the project needs to be covered by a storm water discharge permit.

### **Meaning of the Term “Land-Disturbing Activity”**

A land-disturbing activity includes actions that alter the surface of the land. Such activities include, but are not limited to, such actions as clearing, grading, and excavation. Other examples include final grading, building or maintaining construction access roads, filling, and on-site borrowing. All of these areas should be included when estimating the area undergoing any land-disturbing activity.

### **Meaning of the Term “Storm Water Discharge”**

The NPDES permit is required for storm water discharge from any disturbed areas. The term “storm water discharge” refers to any surface runoff from the disturbed areas of the construction site. Construction site storm water runoff results from rainfall runoff or snow melt. The need for a permit applies regardless of the location of the land-disturbing activity.

## **Obtaining a Permit for Storm Water Discharge for a Construction Project**

Storm water discharges from construction activities are eligible (depending on project size) for permit coverage under the Iowa DNR's General Permit No. 2. General Permit No. 2 is an NPDES permit that applies only to storm water discharge from land-disturbing (construction) activity. The general permit specifies up front all of the terms and conditions required and expected to be met. Linking a specific construction project at a particular site to the general permit is done by filing a notice of intent with the DNR. In this way, the owner or general contractor is officially notifying the DNR of the intent to meet the terms and conditions of the general permit. The instructions for filing a notice of intent to be covered under General Permit No. 2, the permit itself, and all other associated forms can be obtained from the DNR website: <http://www.iowadnr.com/water/stormwater/index.html>.

## **Erosion and Sediment Control Requirements in the NPDES Storm Water Discharge Permit**

Every project must have a pollution prevention plan developed before the notice of intent is submitted to the DNR. The planning and implementation of erosion and sediment control is a crucial component to the pollution prevention plan. Table 1.2 highlights the requirements of Iowa's General Permit No. 2 that relate to erosion and sediment control.

Table 1.2. Requirements in General Permit No. 2 related to erosion and sediment control

<b>Pollution prevention plan</b>	<p>Every project must have a pollution prevention plan developed before the notice of intent is submitted to the DNR. The pollution prevention plan should be kept at the construction site and should be kept up to date. <b>All contractors and subcontractors involved in land-disturbing activities must sign the pollution prevention plan and become co-permittees of the NPDES permit.</b></p> <p>The plan needs to include the following: the sequence of major construction activities and an explanation of how the erosion practices will be phased in with the construction activities; an identification of the selected erosion and sediment controls at the site; each contractor's/subcontractor's role and responsibility in the project and towards erosion and sediment controls; the party(s) responsible for inspection, maintaining, and evaluating the appropriateness of the selected erosion and sediment control practices; and required records of the inspection and maintenance of the sediment and erosion controls.</p>
<b>Run-on controls</b>	<p>To the degree attainable, run-on from undisturbed areas should be diverted from the disturbed areas of the construction site to minimize the amount of area drained for which controls must be provided.</p>
<b>Stabilization practices</b>	<p>During construction, if a disturbed area is to be left idle for more than 21 days, temporary erosion control practices need to be initiated by the 14th day. Temporary erosion control measures include temporary seeding, mulching, geotextiles, etc. These types of practices are aimed at keeping the soil in its original place, rather than capturing it after erosion has occurred.</p>
<b>Structural sediment control</b>	<p>If the area drained is 10 or more acres and there is a common drainageway, a sediment basin with a holding capacity of 3,600 cu ft per acre drained (including off-site area drainage) is to be provided. If a sediment basin is not feasible, comparable erosion control measures on the downslope and sideslopes of the project perimeter are to be provided. For drainage locations serving 10 or fewer acres, structural controls are required for all sideslope and downslope boundaries of the construction area or a sediment basin providing storage for 3,600 cu ft of storage per acre drained must be provided.</p>
<b>Storm water management</b>	<p>The storm water management plan must identify the selected measures that will be installed during construction to control pollutants in storm water discharges that will occur after construction has been completed. After the project is completed and final stabilization is reached, the site's capacity for erosion must be determined? A goal of 80% removal of sediment should be used in designing and installing storm water management practices. Permanent controls may be needed to control erosion from the site. Increased runoff from the site may cause increased erosion downstream. Velocity dissipation devices shall be placed at the discharge location and along the length on any outfall grass channel as necessary to provide a non-erosive flow from the structure to a receiving watercourse.</p>
<b>Inspection and maintenance</b>	<p>Once a week and within 24 hr after a 0.5 in. rainfall, erosion and sediment control practices must be inspected. The practices should be properly maintained and records should be kept. If an existing practice is not working or fails frequently, continued use of that practice should be reevaluated.</p>
<b>Recordkeeping</b>	<p>Records of land-disturbing activities should be kept to determine which areas need to be stabilized. Records on the maintenance and inspection of erosion and sediment control practices must be kept.</p>

## State Erosion and Sediment Control Requirements

Iowa law (Code Section 161A.64) requires that before beginning certain land-disturbing activities, the person conducting the activities must file a signed affidavit with the SWCD stating that erosion caused by the activities will not exceed the district's adopted soil loss limits. For most soils, the limit is an annual soil loss of five tons per acre. Forms for filing the affidavit may be obtained from county SWCD offices.

The requirements for filing the affidavit change if a land-disturbing activity is being carried out within the boundaries of a city or county that has adopted a sediment control ordinance are at least as restrictive as the SWCD's soil loss limits. The SWCD retains primary responsibility for the program, but may share authority through a written agreement with the governmental unit. The affidavit must be filed with that governmental unit rather than the SWCD. The SWCD should be contacted to determine whether any local governmental units in the county have adopted sediment control ordinances and have been delegated authority to receive the affidavits.

Land-disturbing activities covered in Code Section 161A.64 include tilling, clearing, grading, excavating, transporting, or filling land that may result in soil erosion from wind and water and the movement of sediment and sediment-related pollutants off-site. However, the following activities are excluded:

- Tilling, planting, or harvesting of agricultural, horticultural, or forest crops
- Preparation for single-family residences separately built unless in conjunction with multiple construction projects in a subdivision development
- Minor activities such as home gardening, landscaping, repairs, and maintenance work
- Surface or deep mining
- Installation of public utility lines and connections, fence posts, sign posts, telephone poles, electric poles, and other kinds of posts or poles
- Installing septic tanks and drainage fields, unless these are to serve a building whose construction is a land-disturbing activity
- Construction and repair of tracks, right-of-way, bridges, communication facilities, and other related structures of a railroad
- Emergency work to protect life or property
- Disturbed land areas of less than 25,000 square feet, unless a political subdivision by ordinance established a smaller exception or established conditions for this exemption
- The construction, relocation, alteration, or maintenance of public roads by a public body

## Sediment Damage Complaint Procedure

Iowa law (Code Section 161A.47) allows the owner or operator of land being damaged by sediment runoff from eroding land to file a written and signed complaint with the SWCD. Upon its receipt, the SWCD commissioners inspect the complainant's property to determine whether sediment damage is occurring and inspect the land alleged to be causing the damage to determine whether erosion is causing soil loss in excess of the district's adopted limits. If the investigation finds that sediment damage is occurring as a result of erosion in excess of the limits, the commissioners will take action to have the erosion problem corrected.

A recent change in state law also allows district commissioners to file complaints if they believe excessive erosion is causing sediment damage to public property or to private property where public improvements have been made.

## 1.3 SOIL EROSION AND SEDIMENT CONTROL MEASURES MATRIX

An erosion control measures matrix has been developed that parallels the three categories of erosion control measures: vegetative and soil stabilization, structural, and special condition erosion control measures. This matrix will enable the designer or planner to quickly review the various options available and the situations in which the options will perform satisfactorily on the basis of various conditions of the proposed construction site.

The matrix takes into account various conditions, including soil erodibility, degree of slope, climate, topography, and season of the year. These conditions have particular criteria:

- **Perimeter Control.** Planned measures installed around the perimeter of the construction site to prevent surface water from damaging the area during or after construction
- **Slope Protection.** Planned measures installed on or above an erosion slope to prevent soil erosion and sedimentation
- **Borrow and Stockpiles.** An area of the construction site where earth is borrowed (excavated to use as fill at another location) or stockpiled (topsoil is temporarily stored) to be respread following construction
- **Drainage Areas.** The area of land above the development site (including the construction site) that naturally contributes water runoff to the area under construction
- **Sediment Trapping.** Planned measures installed below a potentially erosive area, designed to catch eroded soil temporarily until the area above can be stabilized and/or damage to the area below can be prevented
- **Streams.** A water course flowing naturally through a construction site
- **Temporary Stabilizing.** Planned measures installed to provide temporary cover to an erosive area on a construction site while permanent stabilization of the area is being established
- **Permanent Stabilizing.** Planned vegetation or structural measures installed to permanently prevent a constructed area or finished site from eroding
- **Soil.** The makeup of the top surface of a construction site (texture of soil: sand, silt, or clay) must be taken into account in planning and designing measures to control erosion during and after construction. See your County Soil Survey for details
- **Slope.** The inclination of the land surface from the horizontal, with the steeper and longer slopes having the most erosion potential
- **Effectiveness.** The value of each measure to control erosion over a specified period of time

In the following tables (Tables 1.3 through 1.5), each practice has been analyzed according to the criteria and an X has been marked in each section that pertains to the practice. Information pertaining to a given practice is found on the front and back of each page.

**Table 1.3. Vegetation and soil stabilization erosion control measures**

Measure	Description	A	B	C	D	E	F	G	H	I	J	K	L	M	N	O	P	Q	R	S	T
Compost blanket	A 1- to 4-inch surface application of compost/mulch or a blend to protect areas with erosive potential		X			X		X	X		X		X	X		X	X			X	
Compost filter tube	A tubular mesh sock filled with a specified blend of composted materials, used to slow flow velocity, capture and degrade chemical pollutants, and trap sediment		X			X		X	X	X	X		X	X		X	X		X		
Dust control	A chemical applied to an exposed soil to prevent the movement of dust		X					X		X	X	X	X	X	X				X		
Flocculents	Natural materials or a class of chemicals that cause colloidal particles (clay) to coagulate; the coagulated particles group together to form flocs that will settle out of detained stormwater					X													X		
Grass channels	A temporary drainageway to convey runoff through, along, or around an area; these can be established to serve as permanent controls				X	X	X	X		X	X	X	X			X	X	X	X	X	X
Mulching	Applying plant residue or other suitable material to protect the soil surface		X	X	X			X	X	X	X	X	X	X	X	X			X		
Rolled erosion products (RECP)	Prefabricated blankets or netting which are formed from both natural and synthetic materials		X			X		X	X	X	X		X	X		X	X		X		
Seeding and fertilizing	Seeding grasses and legumes on disturbed soil areas <b>Note: A ground cover of grass is the most effective method of controlling erosion</b>		X	X	X	X		X	X	X	X	X	X	X	X	X	X		X	X	X
Sodding	Bare soil covered with cut sod, usually bluegrass, to provide rapid ground cover and stabilization of the soil; often used in waterways and flumes		X		X				X		X	X	X	X	X	X	X				X
Stream channel vegetation	The use of vegetation to retard stream channel and bank erosion and maintain soil stability				X		X		X	X	X		X	X		X	X	X	X	X	X
Surface roughening	A rough finish on clay soils; this procedure should generally be limited to use only after the fall seeding period has passed to carry a site through the winter months		X					X				X	X	X	X	X			X		
Vegetative filter strip	A strip of grass planted at right angles to the flow of runoff; a 30-foot width is desirable, though as little as 10 to 15 feet can be helpful	X	X			X		X	X		X	X	X	X	X	X				X	X
Wattles	A sediment and stormwater velocity control device, generally tubes of straw, rice straw, or coconut husk encased in ultraviolet (UV) degradable plastic netting or 100% biodegradable burlap material; wattles help stabilize slopes by breaking up the length and by slowing and spreading overland water flow		X			X		X	X	X	X		X	X		X	X		X		

**Key**

- |                         |                         |                           |
|-------------------------|-------------------------|---------------------------|
| A Perimeter Control     | H Permanent Stabilizing | O Drainage Area < 1 acre  |
| B Slope Protection      | I Soil – Sandy          | P Drainage Area 1-5 acres |
| C Borrow and Stockpiles | J Soil – Silty          | Q Drainage Area > 5 acres |
| D Drainage Areas        | K Soil – Clay           | R Effectiveness < 6 mo    |
| E Sediment Trapping     | L Slope 0% - 3%         | S Effectiveness 6-12 mo   |
| F Streams               | M Slope 3% - 8%         | T Effectiveness > 12 mo   |
| G Temporary Stabilizing | N Slope > 8%            |                           |



**Table 1.4. Structural erosion control measures**

Measure	Description	A	B	C	D	E	F	G	H	I	J	K	L	M	N	O	P	Q	R	S	T
Bench	A slightly reverse sloping step on a back slope to reduce slope length		X	X				X	X			X	X	X	X	X			X	X	X
Compost filter berm	A temporary or permanent ridge of soil located so runoff water is channeled to a planned location		X		X		X	X	X		X	X	X	X	X	X	X	X	X	X	X
Check dam	A small temporary barrier or dam constructed across a drainage ditch				X	X		X				X	X	X		X			X	X	X
Diversion structure	A temporary or permanent dike or compost filter berm located so water can be directed to a planned location	X	X		X			X	X	X		X	X	X		X	X		X	X	X
Temporary slope drain	A temporary structure, either metal or flexible pipe, used to carry runoff water from the top of a slope to the bottom	X	X		X	X		X	X	X	X	X	X	X	X	X			X	X	X
Energy dissipator	An obstacle placed at the outlet of a drainage pipe or where a rapid flow of water needs to be reduced to prevent erosion				X		X	X	X	X	X		X	X	X		X	X	X	X	X
Flotation silt curtain	A silt curtain used in a lake or pond to keep silt-laden water within the construction area						X	X		X	X	X	X		X	X	X	X	X	X	
Rock chutes and flumes	A device to transport water in a structure to a lower level without erosion		X		X			X	X	X	X	X	X	X	X	X	X		X	X	X
Silt fence	A temporary barrier of geotextile fabric used to intercept sediment on small drainage areas; one of the most convenient control measures to use on all projects	X	X	X	X	X		X	X	X	X	X	X	X		X	X		X	X	
Gabion	A rectangular wire mesh box filled with rock and used in a variety of places where heavy flexible reinforcement is necessary		X		X		X	X	X	X	X	X	X	X		X	X	X	X	X	X
Inlets	A structure to accept surface runoff and dispose of water in a storm water disposal system				X	X	X		X	X	X	X	X	X	X	X	X		X	X	X
Jetties	A structure used to deflect water current away from selected sections of a streambank				X		X		X	X	X	X	X		X	X	X	X	X	X	X
Level spreader	A water flow outlet device constructed at zero grade so concentrated runoff may empty at non-erosive velocity onto an area stabilized with existing vegetation		X		X			X			X	X	X			X	X		X	X	
Pipe outlet	An apron or other energy dissipating device placed at the outlet of a drainage pipe		X		X			X	X		X	X	X	X		X	X		X	X	X
Retaining wall	A constructed wall to assist in the stabilization of cut or fill slopes where permissible slopes cannot be obtained without the use of a wall	X	X		X				X	X	X	X	X	X		X			X	X	X
Riprap	A permanent erosion resistant ground cover of large, graded, loose angular stone used where water erosion is a problem		X		X		X	X	X	X	X	X	X	X	X	X	X	X	X	X	X
Stabilized construction entrance	A crushed rock or gravel stabilized pad located at points of vehicular ingress or egress at a construction site	X						X	X		X	X	X	X		X	X		X	X	X
Sediment barrier	Temporary structures that allow water-borne silt to settle in the structure while the water continues on				X	X		X		X	X	X	X	X		X			X		
Sediment basin	A basin created by building a dam across a waterway or by excavation or a combination of both; a sediment basin usually consists of a dam, a pipe outlet, and an emergency spillway				X			X			X	X	X	X		X	X		X	X	X
Sediment trap	A depressed area in drainage areas that allows the runoff to slow and the silt to settle				X	X		X		X	X	X	X	X		X			X		
Streambank protection	A permanent structure that will stabilize an eroding streambank				X		X		X	X	X	X	X			X	X	X	X	X	X
Subsurface drainage	A perforated pipe, tubing, or tile installed beneath the ground surface to intercept and convey ground water for suitable disposal	X	X		X			X	X	X	X		X	X		X	X		X	X	X

**Key**

- |                         |                         |                           |
|-------------------------|-------------------------|---------------------------|
| A Perimeter Control     | H Permanent Stabilizing | O Drainage Area < 1 acre  |
| B Slope Protection      | I Soil – Sandy          | P Drainage Area 1-5 acres |
| C Borrow and Stockpiles | J Soil – Silty          | Q Drainage Area > 5 acres |
| D Drainage Areas        | K Soil – Clay           | R Effectiveness < 6 mo    |
| E Sediment Trapping     | L Slope 0% - 3%         | S Effectiveness 6-12 mo   |
| F Streams               | M Slope 3% - 8%         | T Effectiveness > 12 mo   |
| G Temporary Stabilizing | N Slope > 8%            |                           |

**Table 1.5. Special conditions erosion control measures**

Measure	Description	A	B	C	D	E	F	G	H	I	J	K	L	M	N	O	P	Q	R	S	T
Retention pond	A permanent pool of water that has the capacity to store storm water until it is released from the structure				X	X			X			X	X					X			X
Infiltration basin and trench	A depressed area formed by the removal of overburden to expose a porous or sandy soil that allows a flow of runoff water to be absorbed; may also be constructed by excavating a trench and filling it with suitable porous soil				X			X	X	X	X	X	X			X	X	X			X
Serrated cut	Stairstep grading used in soils containing large amounts of soft rock where it may be impossible or impractical to smooth grade		X						X												X
Stream crossing	A temporary structure installed across a flowing stream for use by construction equipment				X		X	X		X	X	X	X					X			X
Wetlands	Important control measure for removal of sediment, nutrients, and urban pollutants by passing runoff water through a constructed wetland area				X	X	X		X	X	X	X	X			X	X	X			X

**Key**

- |   |                       |   |                       |   |                         |
|---|-----------------------|---|-----------------------|---|-------------------------|
| A | Perimeter Control     | H | Permanent Stabilizing | O | Drainage Area < 1 acre  |
| B | Slope Protection      | I | Soil – Sandy          | P | Drainage Area 1-5 acres |
| C | Borrow and Stockpiles | J | Soil – Silty          | Q | Drainage Area > 5 acres |
| D | Drainage Areas        | K | Soil – Clay           | R | Effectiveness < 6 mo    |
| E | Sediment Trapping     | L | Slope 0% - 3%         | S | Effectiveness 6-12 mo   |
| F | Streams               | M | Slope 3% - 8%         | T | Effectiveness > 12 mo   |
| G | Temporary Stabilizing | N | Slope > 8%            |   |                         |

## 1.4 EROSION AND SEDIMENT CONTROL PLAN PREPARATION

This chapter is a guide for the preparation of an erosion and sediment control plan for a construction project. The plan describes the potential for erosion and sedimentation problems on a construction project. The plan also identifies and explains the measures that are to be taken to control those problems. The erosion and sediment control plan must contain sufficient information to ensure that erosion and sedimentation have been adequately addressed for the proposed project. The control plans for a single house development will be far less complicated than a large development on steep slopes or rough terrain.

This plan should have two parts: the written portion or narrative and the map or site plan. The narrative explains the erosion and sediment control decisions for a particular project and the justifications for those decisions. It is important that adequate information is provided in the narrative.

The owner or lessee of the land being developed is responsible for the plan preparation. The owner or lessee may engage an engineer or other qualified person to prepare the plan; however, the owner or lessee still has the responsibility for ensuring development of an acceptable plan.

### Plan Preparation

Five steps are needed for adequate development of an erosion and sediment control plan:

1. Data inventory
2. Data analysis
3. Site plan development
4. Erosion and sediment control plan
5. Plan preparation

#### Step 1. Data Inventory

Gather information that will help develop the most effective erosion and sediment control plan. The information obtained should be plotted on a map and explained in the narrative portion of the plan. Such a narrative should include the following topics:

- **Aerial photo of site.** An aerial photo of the site and adjacent lands should be obtained and used to identify important site characteristics, as well as features of adjacent lands that should be considered in developing the erosion and sediment control plan. A color infrared map and a soils map of a site can be obtained from the following website: <http://igsims.igsb.uiowa.edu/website/basic/viewer.htm>.
- **Topography.** A topographic map of the site should be prepared to show the existing contour elevations at intervals of 1–5 feet, depending on the slope of the ground.
- **Drainage patterns.** All existing drainage ditches and swales must be located and indicated on the topographic map.
- **Soils.** Major soil types should be shown on the topographic map or on an overlay of the same scale for ease of interpretation.

- **Ground cover.** The existing vegetation on the site should be shown. Features such as trees, shrubs, grassy areas, native grasses, and existing denuded or exposed soil and rock outcrops should be indicated.
- **Adjacent areas (upstream and downstream).** Areas adjacent to the proposed development site should be indicated on the topographic map, including features such as streams, roads, buildings, and wooded areas. Anticipated runoff velocities and volumes from those areas should be calculated to determine the types of erosion control or flow diversion techniques that should be employed on the construction site. Streams that will receive runoff from the site should be surveyed to determine their carrying capacity and ways to control sedimentation prior to water leaving the site.

### Step 2. Data Analysis

When the information in Step 1 is compiled, a picture of the site possibilities begins to emerge. The important points to consider in site analysis are as follows:

- **Topography.** The primary considerations are slope length and steepness. Longer and steeper slopes will increase the runoff flow and the erosion potential. When the percent of slope has been determined, areas of similar steepness should be grouped together. Slope gradients should be grouped into three general ranges of soil erodibility:

0%–3%—low erosion potential  
3%–8%—medium erosion potential  
over 8%—high erosion potential

Within these slope ranges, the greater the slope length, the greater the erosion potential. Generally the erosion potential becomes more serious if the slope lengths exceed the following distances:

0%–3%—300 feet  
3%–8%—150 feet  
over 8%—75 feet

- **Drainage patterns:** Natural drainage patterns exist on the land. These patterns, which consist of overland flow, swales and depressions, and natural waterways, need to be identified so that critical areas can be located where water will concentrate. The natural waterways should be used wherever possible rather than incurring the expense of constructing and maintaining an artificial waterway. Care should be taken ensure that any increase in runoff from the site will not erode or flood the existing drainage system or cause downstream damage. Such a location may require a retention pond.
- **Soils.** Soil characteristics need to be identified to determine permeability, shrink-swell potential, texture, erodibility, and water table depth and depth to bedrock. This information can be obtained from the local SWCD office or from the following website: <http://www.itc.nl/~rossiter/Docs/NRCS/620nsh.pdf>.
- **Ground cover.** A dense grass ground cover is the most important feature for preventing erosion. All existing vegetation that can be saved will help prevent erosion. This includes trees, shrubs, and other vegetative cover. Construction that can be staged, which involves stabilizing one part of the site before disturbing another, will reduce the erosion potential as well as the amount of temporary seeding and mulching required.

- **Adjacent areas.** Careful analysis of adjacent properties, especially areas upslope and downslope from the construction project is necessary. To prevent erosion from occurring in the construction area, upstream property runoff velocities and volumes must be controlled as they enter the site or flows must be diverted. Special consideration must be given to watercourses that will receive runoff directly from the construction site. The potential for sediment pollution of the watercourses needs to be considered, as well as downstream erosion due to an increased volume of runoff. The potential for sediment deposition on adjacent properties due to sheet and rill erosion should also be considered so appropriate sediment trapping measures can be planned.

### Step 3. Site Plan Development

After reviewing the data and noting the site limitations, development of the site plan can begin. The planner should locate the proposed buildings, roads, and parking areas, and develop a landscape plan to exploit the strengths and take into account the limitations of the site. The following items should help in the planning decisions:

- **Fit the development to the site conditions.** Doing so will avoid unnecessary land disturbance, minimize cut and fill, and reduce erosion potential and development costs.
- **Limit construction activities to the least critical areas.** Land disturbance of the more erodible areas will require the installation and maintenance of costly control measures. Cluster buildings together: this plan will reduce the amount of disturbed area. Concentrating utility lines and connections in one area will provide more natural open space. The cluster concept lessens the erodible area, reduces runoff, and usually reduces development costs.
- **Minimize paved areas.** Keep paved areas such as roads, drives, and parking lots to a minimum. The more land kept in vegetative cover, the more water will infiltrate, thus minimizing runoff and erosion.
- **Use the natural drainage system.** By retaining the natural drainage system, the potential for downstream damage due to increased runoff can be minimized and storm water management made easier.

### Step 4. Erosion and Sediment Control Plan

Once the plan for the site has been decided, a plan to control erosion and sediment from the disturbed areas must be prepared.

The planner should refer to Section 1.6 of this manual, “Implementation Guidelines, Erosion Control Measures,” to help select the most appropriate control measure. The following procedure is suggested for erosion and sediment control planning:

- **Determine the limits of clearing and grading.** Determine which areas must be disturbed for the proposed construction. Note critical areas that must be disturbed.
- **Divide the site and adjacent runoff-contributing properties into individual drainage areas.** Determine how the runoff will travel over the site. Determine how erosion and sedimentation can be controlled in each small drainage area before reviewing the whole site. It is easier to control erosion than to contend with sediment after it has been carried downstream.
- **Select erosion and sediment control measures for the construction site and the runoff contributions of adjacent runoff contributing areas.** Erosion and sediment

control measures can be divided into three categories: vegetation and soil stabilization measures, structural measures and special conditions.

- *Vegetation and soil stabilization measures.* The objective is to prevent erosion and to protect the soil from the impact of raindrops and the overland flow of runoff. The best way to protect the soil is with a cover of grass. If disturbance is necessary, seed, mulch, and fertilize the area as soon as possible. If the area will be disturbed again, then temporarily seed the area and mulch if necessary. The erosion and sediment control plans must contain provisions for permanent stabilization of the disturbed areas. Selection of permanent vegetation should include the following considerations: establishment requirements, adaptability to the site, aesthetics, and maintenance requirements.
  - *Structural measures.* Structural measures are generally more costly and less efficient than vegetation. Nevertheless, they are usually necessary, since not all disturbed areas can be protected with vegetation. However, it is very important that the structural measures selected be designed and installed according to standard engineering practices. Improper use or incorrect installation can create larger problems than those the structure was designed to solve.
  - *Special conditions.* These measures are needed for special situations and may require a special design for an installation.
- **Storm water permit requirements.** Land-disturbing activities that will disturb an area of one or more acres are required to be covered by an NPDES permit. The stormwater permits are managed by the Environmental Services Division of the Iowa DNR, Wallace State Office Building in Des Moines, Iowa.

### Step 5. Plan Preparation

The planning work has been done in Steps 1–4. The final step consists of consolidating the pertinent information and developing a specific erosion and sediment control plan for the project. The plan consists of two parts: a narrative and a site plan. The narrative explains the problems and the solutions, along with necessary documentation. The site plan is one or a series of maps or drawings showing the location of the various control measures. The following checklist should be included in the plan:

- **Description.** Describe the land, purpose, and the amount of grading involved.
- **Site conditions.** Describe the existing topography, vegetation, and drainage.
- **Adjacent areas.** Describe the neighboring areas, drainageways, buildings, streams, roads, land use, etc.
- **Soils.** Briefly explain the soils, soil names, soil depth, erodibility, and texture.
- **Critical areas.** Note areas on the site that have potentially serious erosion problems.
- **Erosion and sediment control measures.** The measures selected for use on the site are listed and illustrated in Chapters 2–4 of this document.
- **Permanent stabilization.** Briefly describe how the site will be stabilized after construction is completed.
- **Stormwater permit requirements.** Identify whether the development of the site will increase the runoff and whether a discharge permit will be required.
- **Maintenance.** Provide a schedule for inspection and repair of erosion and sediment control measures.

- **Calculations.** Calculations for the design of such items as sediment basins, diversions, waterways, and retention basins should be included.
- **Wetlands.** Identify steps to be taken to comply with all regulations and include drainage patterns.

The following checklist should be included in the site plan:

- **Location map.** Show the location of the proposed construction site in relation to the surrounding area on the map.
- **Identify owner and developer.**
- **North point.** Indicate the north point and the scale.
- **Contours.** Show the existing contours of the site on a map.
- **Existing vegetation.** Show tree and shrub lines, grassy areas, or special vegetation on a map.
- **Soils.** Show the boundaries of different soil types on a map.
- **Critical erosion areas.** Indicate areas with the potential for serious erosion problems on a map.
- **Drainage patterns.** Show the dividing lines and the direction of flow for the different drainage areas on the map.
- **Final contours.** Show changes to the existing contours on a map.
- **Clearing and grading.** Outline areas to be cleared and graded on a map.
- **Location of control measures.** Indicate the location of the various erosion and sediment control measures on a map.
- **Drawings.** As necessary, provide detailed drawings and explanations of structural control measures, especially for measures not referenced in this manual.

## 1.5 SAMPLE SITE PLANS

In this section, all information presented in Section 1.4, “Erosion and Sediment Control Plan Preparation,” will be put to use in the development of an erosion and sediment control plan for a proposed construction project. Since this is an exercise, the development of the sample plan will be brief; however, it is important that all issues be addressed.

### Plan Development

The erosion and sediment control plan for this project was developed according to the step-by-step procedure outlined in Section 1.4. For training purposes, each step is discussed separately with corresponding maps to illustrate what was done. This plan consists of four maps, shown in Figures 1.2 through 1.5, though information on Figures 1.2 and 1.3 could have been combined on one map. However, planners may choose the method they wish to present the information.

#### Step 1: Data Collection (Figure 1.2)

The topographic information was obtained by aerial survey and shown on the map in Figure 1.2 at a scale of 1 in. = 200 ft, with 2 ft contours.

From an on-site inspection, as shown on the topographic map, the site has three watersheds, each drained by a distinct swale. Land use and slopes of adjacent upstream properties must also be identified to analyze the potential overland control needs.

The soils information is available from the SWCD office. This site has slopes that range from a 2% to a 25% grade. Each soil type is identified by a symbol. The first two numbers identify the soil name; the letter B, C, or D indicates the degree of slope, from gently sloping to moderately steep. The final number, 2 or 3, indicates whether the soil is currently in an eroded or severely eroded condition. The lack of a final number indicates slight to no erosion.

An on-site investigation was made to determine the existing vegetation. Tree lines are shown on the top of the map along with the type of grass cover on the site.

The land use of the adjacent properties is indicated on each side of the proposed development tract.

#### Step 2: Data Analysis (Figure 1.3)

In terms of topography, the site consists of a series of ridges and valleys running from west to east. The areas that have the steep (10% to 20%) slopes should be avoided if possible.

The three major drainage areas identified as areas I, II, and III on Figure 1.2 have approximately 35 acres, 20 acres, and 28 acres, respectively. Each area is drained by a well-defined swale. These swales should continue to be used. Extreme care should be exercised to control any erosion that might occur during construction.

Information about the major soil types should be related in the narrative. Soils that have a high degree of erodibility should be noted on the map.



Ground cover conditions should be noted, and the growth that should be saved should be identified in the field and on the development plans.

The adjacent areas downstream must be protected from large flows of sediment during construction. The flow intensity across the site should be managed to retain sediment on site and prevent downstream erosion. Adequate erosion and sediment control measures must be in place before construction begins. The two highways should be protected from the possibility of construction traffic tracking mud on them.

### **Step 3: Site Plan Development (Figure 1.4)**

Figures 1.2 and 1.3 were used to determine the most suitable areas for development and the most critical areas from an erosion control standpoint. Erosion potential is a factor to be considered in locating the many features of the plan.

The final site plan, shown in Figure 4, was developed through a balanced evaluation of such factors as convenience, drainage, maintenance, costs, aesthetics, and erosion potential during construction and stormwater runoff after construction.

Access roads were located to follow the existing topography as nearly as possible so that grading could be minimized.

The two major buildings were located on either side of the swale in Drainage Area II with a connecting walkway to minimize disturbance within the swale.

The parking areas were clustered around the buildings for convenience and to centralize land disturbance in one major area.

The existing drainage swales were preserved to continue draining the site. A storm sewer was located along the swale in Drainage Area I to follow the existing grade and minimize land disturbance.

The tennis courts and ball fields were located to take advantage of the flattest areas on the site. Although the ball field is located over a highly erosive soil, the flat grade should minimize erosion.

Development is basically confined to Drainage Areas I and II. There will be no increase in erosion potential in Drainage Area III during construction. There should be no potential for damage to adjacent areas on the southern border of the site, and flow intensity changes should be minimized. Care should be taken to reduce the velocity and volume of runoff during and immediately after a rainfall event.

### **Step 4: Erosion & Sediment Control Plan Preparation (Figure 1.5)**

The limits of grading are outlined on the site plan (in Figure 1.4) so the areas requiring erosion and sediment control practices can be determined. Because construction will take place in two separate drainage areas, the erosion and sediment control plans were considered for each drainage area as follows:

### **Drainage Area I**

Land disturbance in this area consists of grading access roads, a parking area, tennis courts and a baseball field. The objective is to keep sediment from entering the natural drainage swale leading to Courthouse Creek. This will be done by a combination of management and vegetative methods to minimize erosion potential and structural measures to retain sediment that is unavoidably generated.

### **Drainage Area II**

The major portion of the construction will take place in this area. This includes grading for three buildings, three parking lots and access roads, and future buildings and parking. A storm sewer system is also planned to be built along the swale.

It is likely that a considerable amount of sediment and an increased level of runoff flow will enter the drainage swale during construction. The objective will be to reduce flow velocities and minimize erosion by using vegetative controls and management methods to trap sediment before it enters the creek.

### **Structural Controls, Area I**

1. A system of temporary diversion structures and sediment traps below the graded areas will be used to trap and filter sediment before it enters the drainage swale.
2. A temporary construction entrance will allow muddy tires to be cleaned before entering the highway.
3. The potential exists for erosion at the outlets of drainage pipes. Thus, riprap is planned at the outlets to dissipate energy and prevent erosion.
4. Not shown in the example are measures required to control the flow from upstream properties and along the perimeter at the outlet of each drainage area. Control measures placed to intercept adjacent property runoff must consider land use vegetation changes over the time of construction. Perimeter measures must consider the potential for failure or overload of the on-site erosion control measures.

### **Structural Controls, Area II**

1. Drainage Area II is completely drained by a single swale. A sediment basin constructed across the swale below all construction is the most effective method to remove sediment from runoff before it enters the creek.
2. Sediment-laden water will be filtered before entering the storm drain system during construction. The type of inlet protection being used should be clearly identified.
3. A cluster of trees and other vegetation should be protected from sediment deposition during construction. A silt fence will provide the necessary protection.

### **Vegetative Measures, Areas I and II**

1. Topsoil will be stripped, stockpiled, and spread at a later time. Stockpiles should be located in a safe area and protected by seeding and mulching.
2. Temporary seeding will be done on graded areas where further work will be delayed three weeks. Diversion structures and the sediment basin embankment will also be seeded with temporary seeding.
3. Permanent seeding will be applied in accordance with the overall landscape plan for the site.

4. An excelsior mat will be used as a temporary liner in all the drainage ditches and as an aid in grass establishment

**Management, Areas I and II**

1. Construction traffic will be limited to access roads and areas to be graded. All traffic will be prohibited from crossing drainage swales and streams, except where necessary.
2. The sediment basin, diversion structures, and sediment traps will be installed as a first step in grading.
3. As soon as the major grading is done, temporary or permanent seeding will be applied in the respective areas.
4. Responsibility for implementing the plan should be transferred to the construction superintendent. The superintendent should make all workers aware of the provisions of the plan.
5. All erosion and sediment control measures should be checked continuously and after each significant storm to locate and repair damages and conduct maintenance operations.

**Step 5. Prepare the Plan**

In Steps 1–4, all of the information necessary for preparing an erosion and sediment control plan was developed. In this final step, the actual plan is to be prepared containing all of the pertinent information in a logical format. The checklist at the end of Section 1.4 was used as a basis for developing the erosion and sediment control plan as shown in Figures 1.2–1.5.

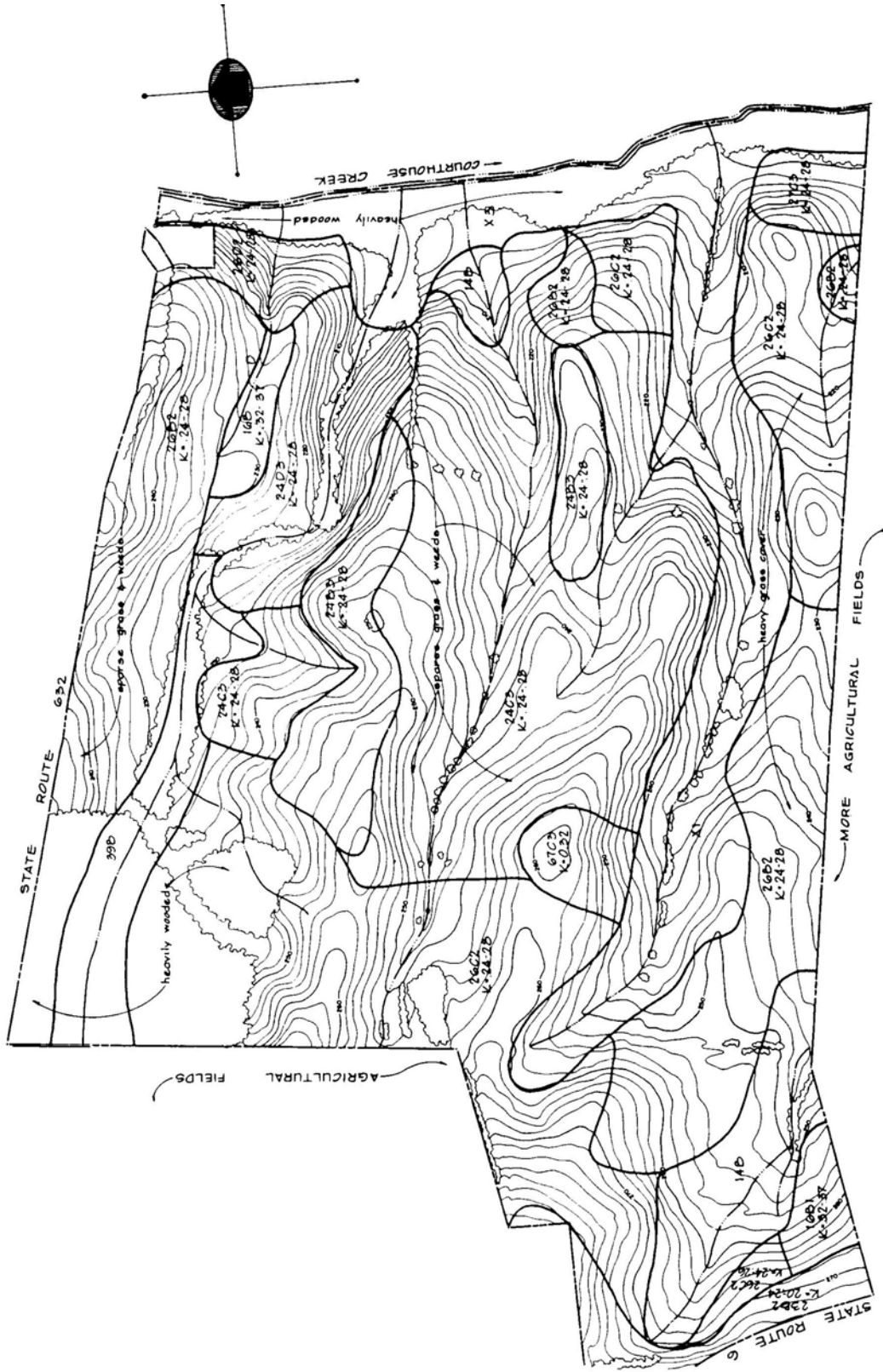

Figure 1.2. Data collection worksheet

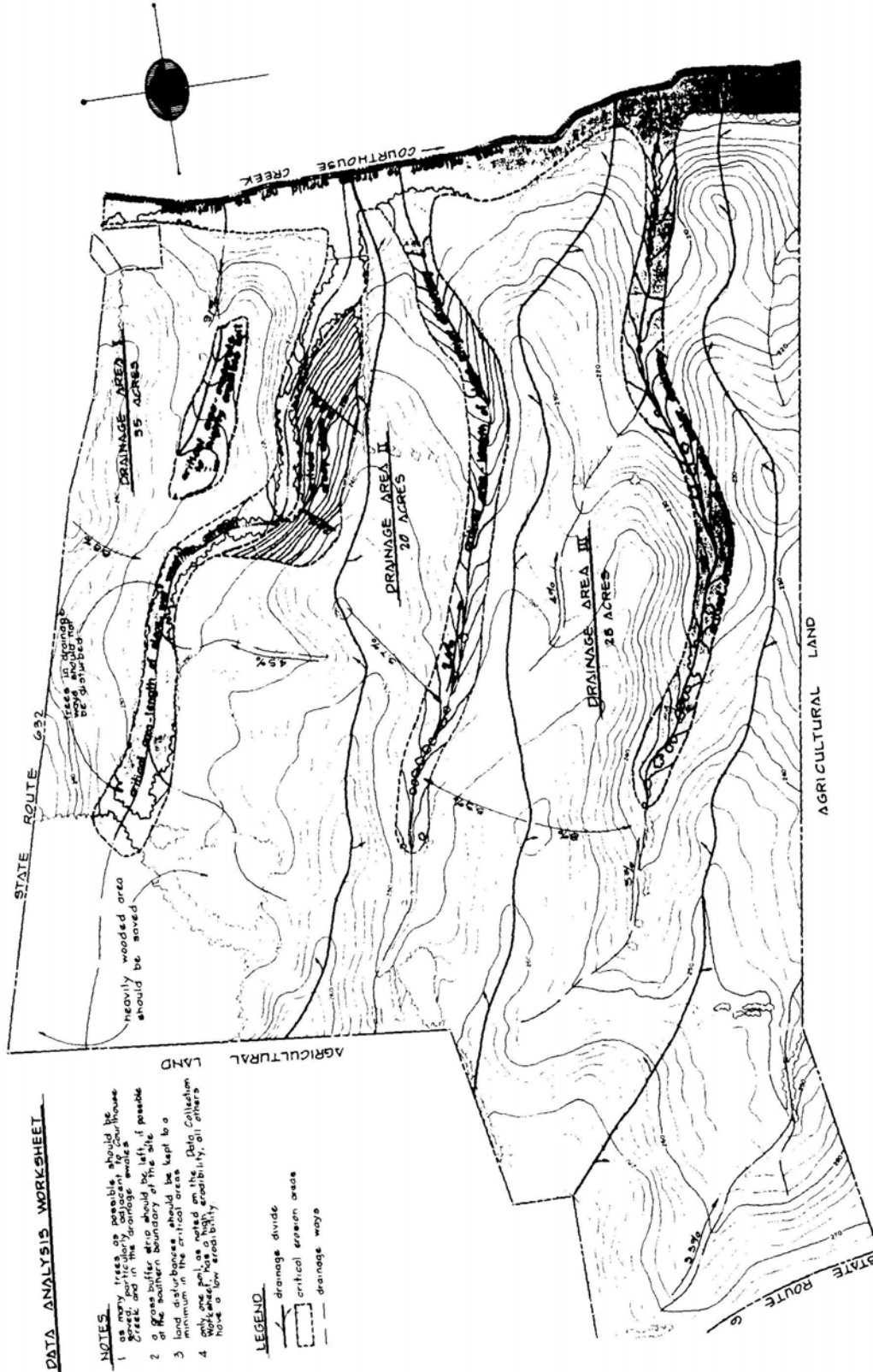

Figure 1.3. Data analysis worksheet

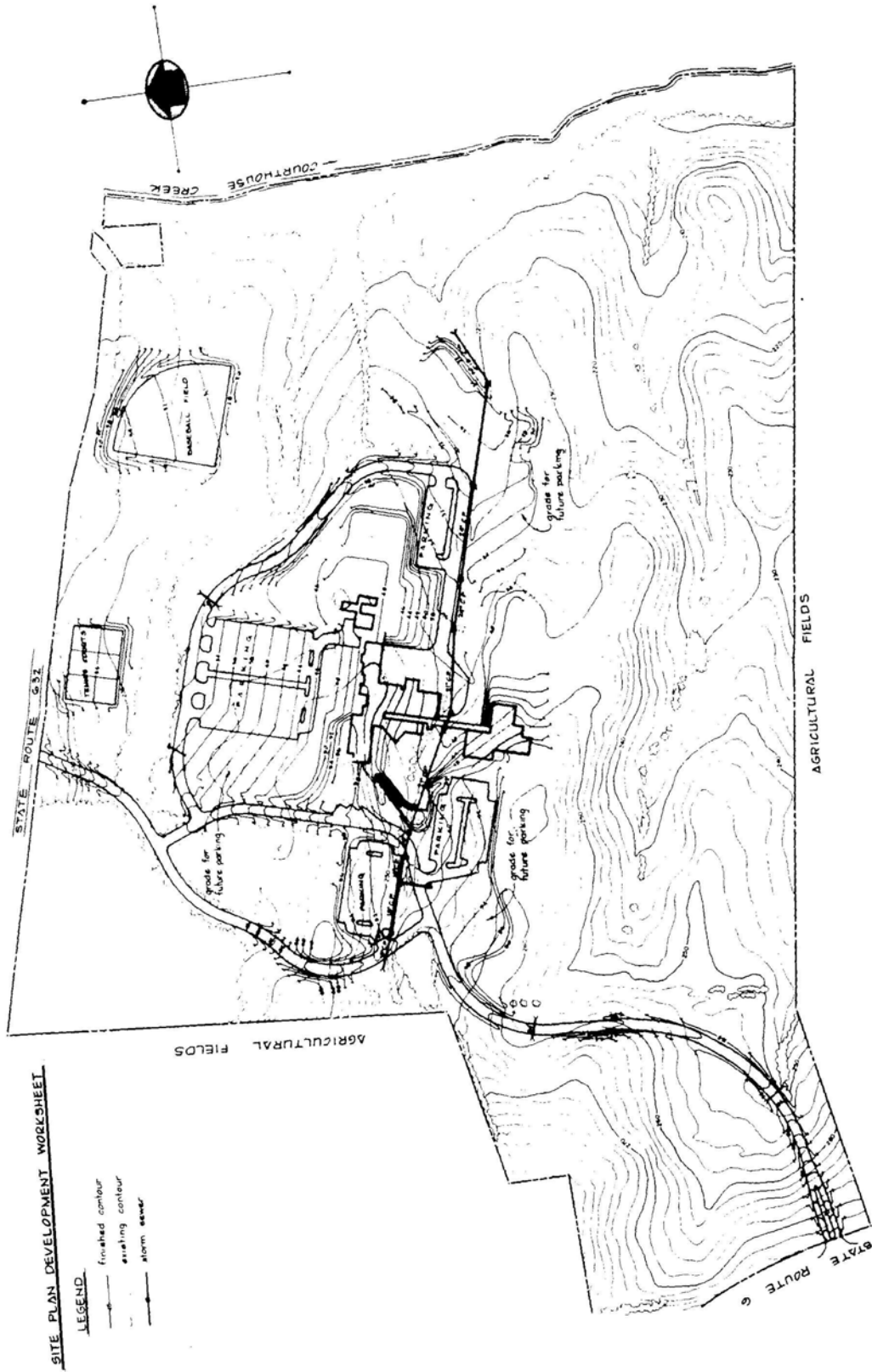

Figure 1.4. Site plan development worksheet



## 1.6 IMPLEMENTATION GUIDELINES

### Planning

Planning is necessary if effective solutions are to be provided for erosion and sediment control on construction sites. Plans can guide development and prevent waste. In planning, the permanent features of the development should conform to the natural characteristics of the site.

Soil survey information provides an understanding of the capabilities and general limitations of a site. The soil survey contains information on the feasibility of planned land uses, economic considerations, and the conservation requirements of the site. Detailed soil maps and related data are available in the local SWCD offices and will provide the following information:

1. Descriptions, erodibility, capabilities, and construction limitations
2. Soil properties and suitability of soil material for topsoil, gravel, and sand or for dams and levees
3. Construction site suitability for roads, buildings, septic systems, sanitary landfills, vegetation, reservoirs, dams, recreation areas, or wildlife development

Addresses, fax numbers, and phone numbers of the local SWCD offices can be found at <http://www.agriculture.state.ia.us/swcdnm.asp>.

An erosion and sediment control plan is necessary for all of the land to be developed. A great deal of information must be reviewed to develop an effective plan for the construction site. The erosion and sediment control plan needs to show the existing topography and how it will be changed. The plan needs to indicate what control measures will be used and how and when they will be installed, maintained, and coordinated with the phasing schedule.

### Site Management

Efficient site management for effective erosion and sediment control may involve the following considerations:

- Keep silt on the construction site.
- Clear and grade only what is needed for immediate construction; avoid complete clearing and grading; stabilize disturbed areas as soon as possible; divert runoff from highly erodible soils and steep slopes.
- Mark protected areas so workers can see the area. Plastic snow fencing is a good material to use to protect and define the area.
- Ensure all workers understand the provisions of the erosion and sediment control plan.
- Have one person responsible for implementing the erosion and sediment control plan.
- Arrange for routine inspection of all erosion and sediment control measures. When the sediment traps are half-full, they should be cleaned and the sediment disposed of on-site and in an area where sediment will not fill the trap during the next precipitation event. Inspections should be made of all control measures following each precipitation event.

As an aid in planning, refer to the flow charts in Figures 1.6–1.8.



## **Drainage**

Safe disposal of runoff water from a construction site is a major concern. For information about drainage ditch design, see the Natural Resources Conservation Service Engineering Field Handbook. A major item in ditch design is stability of the soil.

## **Vegetated Channels**

The following information will be helpful in designing channels and waterways. Additional details may be found in Chapter 2 under Vegetation and Soil Stabilization Erosion Control Measures: Grass Channels.

When the channel can be protected from erosion, the allowable velocities can be increased, resulting in deeper and narrower channels. An inexpensive and permanent form of protection is vegetation, specifically grasses. Vegetation protects the channel material from the erosive action of the flow and binds the channel material together.

Vegetated waterways generally can be used to carry intermittent flows such as storm water runoff. However, they are not recommended for channels having sustained base flow, as most vegetation cannot survive continual submergence or continual saturation in the root zone. For example, vegetated waterways would not be used as the channel carrying the discharge from a pipe spillway in a detention basin because this flow is likely to be sustained. A compound channel with a small, lined channel in the center to carry base flows and a vegetated portion to carry storm flows may be used in these situations.

Vegetated waterways are somewhat more complex to design and require more care in their establishment than waterways without vegetation. They will carry high flows at high velocities and require a minimum of maintenance if properly constructed.

Typically, a tall grass presents a great deal of flow resistance to shallow flow. As the flow depth increases, the resistance may decrease. Often the grass will lay over in the direction of flow when the flow reaches sufficient depth. In this condition, the resistance is considerably reduced as compared to the shallow flow situation.

Grasses have been divided into five classes by their ability to retard flow (retardance). The classes are designated A, B, C, D, and E. If the grass will be mowed part of the time and left long part of the time, both the flow conditions and retardance classes must be considered. See Tables 1.6–1.8 for flow retardance classification.

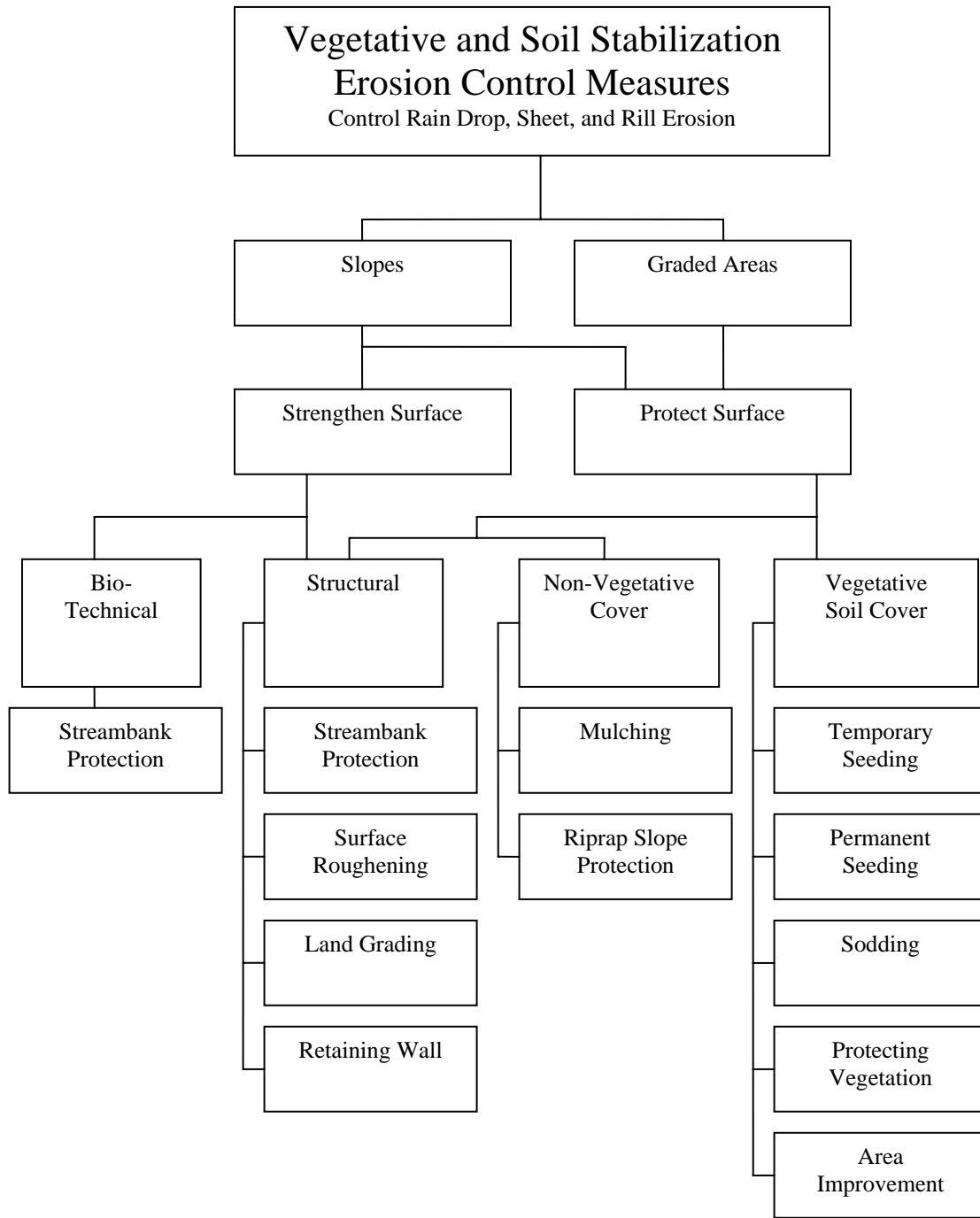

Figure 1.6. Vegetative and soil stabilization erosion control measures

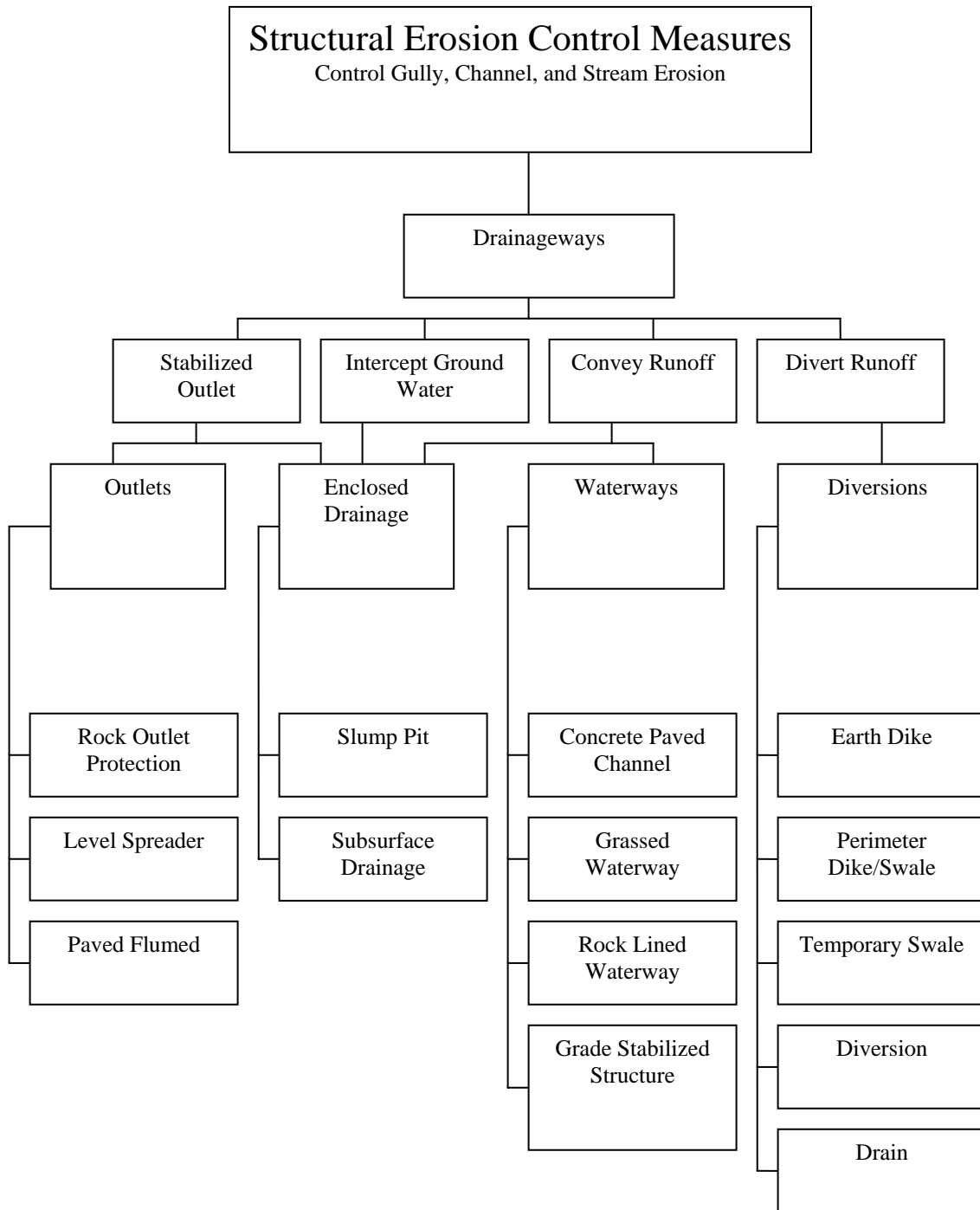

Figure 1.7. Structural erosion control measures

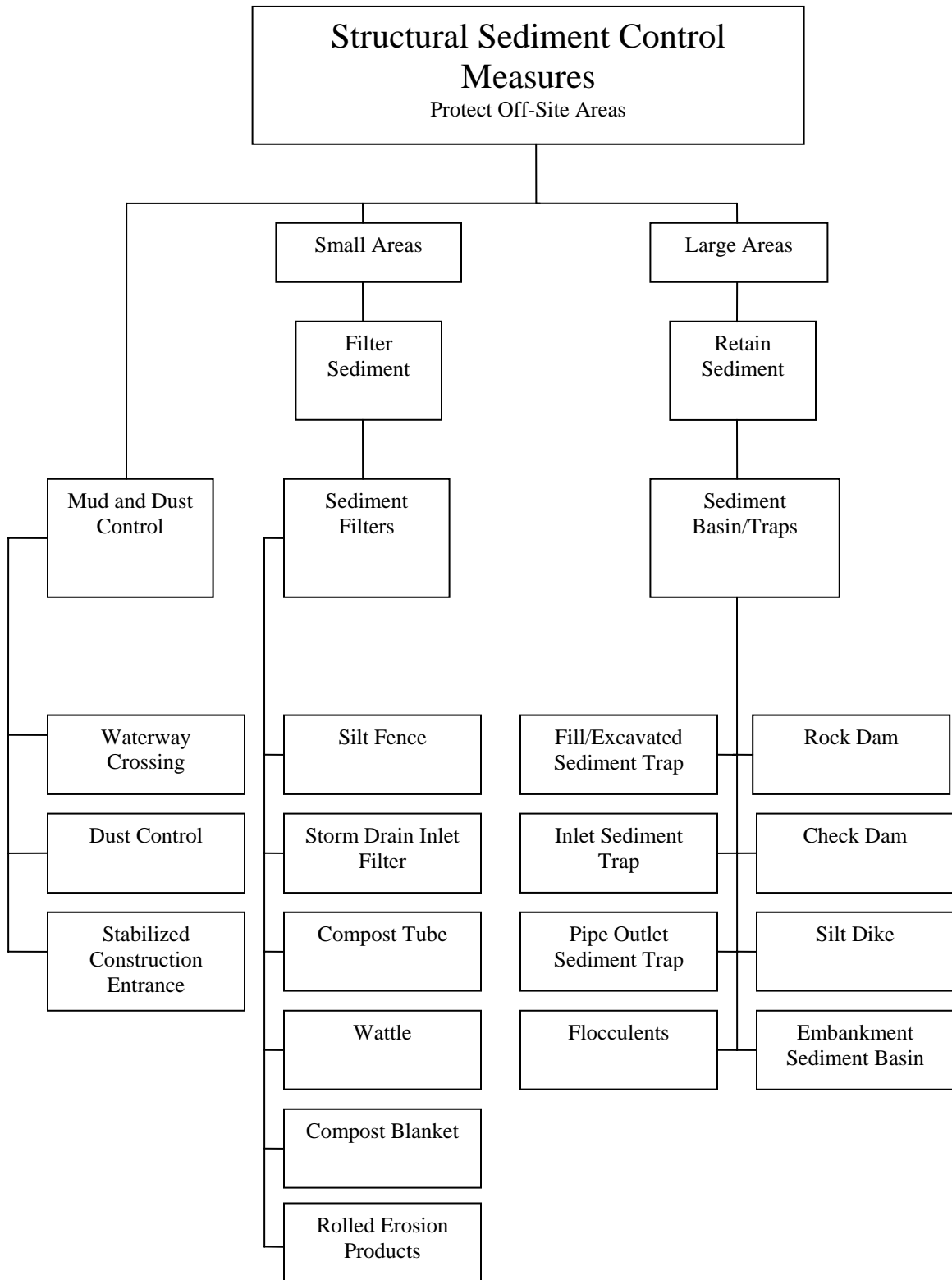

Figure 1.8. Structural sediment control measures

**Table 1.6. Classification of vegetal cover in waterways based on degree of flow retardance by vegetation (Source: U.S. EPA 1976)**

Retardance	Cover	Stand	Condition and height
A	Reed canarygrass	Excellent	Tall (average 36 in.)
	Kentucky 31 in. tall fescue	Excellent	Tall (average 36 in.)
B	Reed canarygrass	Good	Mowed (average 12 to 15 in.)
	Kentucky 31 in. tall fescue	Good	Unmowed (average 18 in.)
	Red Fescue	Good	Unmowed (average 16 in.)
	Kentucky bluegrass	Good	Unmowed (average 16 in.)
	Redtop	Good	Average
C	Kentucky bluegrass	Good	Headed (6 to 12 in.)
	Red fescue	Good	Headed (6 to 12 in.)
	Redtop	Good	Headed (15 to 20 in.)
D	Red fescue	Good	Mowed (2 ½ in.)
	Kentucky bluegrass	Good	Mowed (2 to 5 in.)

**Table 1.7. Grass establishment alternatives (Source: VSWCC 1980)**

Establishment Technique	Conditions	Remarks
1. Seeding with straw mulching and tack coat	<ol style="list-style-type: none"> <li>1. Slopes less than 10%–15%</li> <li>2. Velocity less than 3 fps</li> <li>3. Majority of drainage cannot be diverted away from channel during germination and establishment</li> <li>4. Erosion-resistant soils</li> </ol>	<ol style="list-style-type: none"> <li>1. See permanent seeding requirements. When mulching, use 2 tons/acre small grain straw with an acceptable tacking agent.</li> </ol>
2. Seeding with straw mulching and jute mesh or erosion netting	<ol style="list-style-type: none"> <li>1. Slopes less than 10%–15%</li> <li>2. Velocity less than 5 fps</li> <li>3. Majority of drainage cannot be diverted away from channel during germination and establishment</li> <li>4. Moderately erodible soil</li> </ol>	<ol style="list-style-type: none"> <li>2. In addition to the first technique, straw mulching should be secured with netting. If using jute mesh, use only 1 ton/acre small grain straw, evenly distributed. If using a light plastic or paper erosion netting, 1 1/2 to 2 tons/acre of straw is appropriate. Excelsior blankets, used alone, are also acceptable mulching for waterways.</li> </ol>
3. Sodding	<ol style="list-style-type: none"> <li>1. Slopes greater than 10%–15%</li> <li>2. Velocity between 5 and 6 fps</li> <li>3. Majority of drainage cannot be diverted away from channel during germination</li> <li>4. Highly erodible soil</li> </ol>	<ol style="list-style-type: none"> <li>3. See Sodding section for soil installation requirements.</li> </ol>

**Table 1.8. Maximum flow velocities (Source: USDA, SCS 1979b)**

<b>Channel lining</b>	<b>Maximum velocity (fps)</b>	
Natural channels not completely clear	Water transporting	
<i>Lined with vegetation</i>	<i>Water</i>	<i>Colloidal silt</i>
(1) Sand and sandy loam	1.50	2.5
(2) Silt loam	2.00	3.0
(3) Sandy clay loam	2.00	3.5
(4) Clay loam	3.00	4.0
(5) Clay, fine gravel, and graded loam to gravel	3.75	5.0
(6) Graded silt to cobbles	4.00	5.5
(7) Shale, hardpan, and coarse gravels	6.00	6.0

## Intercepting and Diverting Runoff

The water-handling structures discussed here are used to divert collected flow away from critical areas, and discharge collected runoff in suitable disposal areas, and intercept surface water runoff before it can cause damage. Structures used to collect and convey runoff are generally referred to as diversion structures. Diversion structures serve to do the following:

- Prevent surface runoff from higher undisturbed or stabilized areas from coming in contact with exposed soil surfaces
- Direct on-site water away from critical areas such as steep slopes, highly erodible soil, and landslide-prone areas
- Prevent sediment-laden runoff from an exposed slope from leaving the restoration site without first passing through a sediment-detention structure

Typical diversion structures are dikes, swales, ditches, or a dike and ditch combination. Diversion structures are ridges of compacted soil placed above, below, or around a disturbed area. Diversion swales are excavated temporary drainageways used above and below disturbed areas. Diversions are permanent or temporary drainageways constructed by digging a shallow ditch along a hillside and building a soil dike along the downhill edge of the ditch with the excavated soil.



**Figure 1.9. Intercepting and diverting runoff (Source: Iowa DOT)**



**Figure 1.10. Diversion structure (Source: Virginia Department of Conservation & Recreation)**



Figure 1.11. Diversion dike and swale combination (Source: ISU/CCEE)

## Handling and Disposing of Concentrated Flows

In handling concentrated water flows, the primary goals are to control the flow's distance, decrease the gradient, and obstruct the flow. Flow distance may be controlled by lengthening drainageways. However, care must be taken to ensure that the resulting flow will not erode or overflow the channel. Flow gradient can be controlled through the placement of check dams and other flow control structures across the channel. Grade control structures also serve to obstruct flow within the channel and, as a result, slow its movement. Placement of the water-handling structure nearly parallel to the ground contour is a means of controlling the gradient and maximizing the flow distance. Again, care must be taken to ensure that the channel can carry the design flow without overtopping in critical areas, such as along erodible slopes.

Materials such as rock riprap placed in the channel will dissipate the energy of the flow. This will also reduce the ability of the concentrated flow to cause erosion. Energy dissipators should be placed below grade control structures and outfalls, and when necessary, along the outside of channel bends. Further information on the design of energy dissipators can be found in the Federal Highway Administration's Hydraulic Engineering Circular No. 14 (1975). See [www.ntis.gov](http://www.ntis.gov) or call (703) 487-4650 for the publication.

Structures used to control concentrated flow include downdrain structures (rock chutes, flumes, and pipe slope drains) and waterways. Paved chutes (flumes) are channels extending from the top to the bottom of the slope and lined with non-erodible material such as bituminous concrete, portland cement, or grouted riprap. Rock chutes (flumes) are constructed in the same manner as paved chutes, but utilize natural stones or riprap materials. Pipe slope drains may be rigid pipe or flexible tubing connected to the prefabricated inlet section. These are considered temporary measures and extend from the top to the bottom of a slope.



Waterways are stabilized channels designed to handle the anticipated flow rate safely. Channel linings vary according to flow rates. Grade control structures and energy dissipators are also used to stabilize the channel for high-velocity water flow. See Tables 1.9 and 1.10.

Each water control structure must have a stable outlet. The outlet may be a natural drainageway, vegetated area, or other stable watercourse. In all cases, the outlet must convey the water without incurring erosion. Disposal of small flows in upland areas can be performed by using a level spreader. The structure is a well-stabilized outlet constructed at zero percent grade (along the outlet lip) that converts concentrated flow into less erosive sheet flow. The flow is discharged onto a vegetated slope in an area where the water will not be reconcentrated immediately below the structure.

Impoundment structures may also be used to control runoff by trapping sediment from the site and reducing downstream channel erosion and flooding problems. Trapping sediment is their primary function. However, when increased runoff is expected, off-site erosion and flooding potential should also be given careful consideration in the design and construction of water detention or retention structures. Impoundment structures such as sediment basins detain runoff and release it at a controlled rate. Thus, the ability of the inflowing water to carry sediment is reduced.

**Table 1.9. Waterway linings in order of increasing flow velocity and handling capacity**

Type	Remarks	Maintenance
Grass	<ul style="list-style-type: none"> <li>• Need to divert water to establish vegetation</li> <li>• Lime, fertilize, seed, and mulch</li> <li>• Methods of keeping seeds and seedings on steep slopes (using cloth, latex spray, chemical tacks, etc.)</li> <li>• Cut mulching at 90<sup>o</sup> to line-of-flow with rolling cultipacker</li> </ul>	<ul style="list-style-type: none"> <li>• Fertilize</li> <li>• Mow at height of 4–6 in. at least two times per year to prevent thatching of grass (Do not mow unless waterway will support equipment. Waterlogged soils in spring should be avoided.)</li> <li>• Rotor mower preferable to sickle bar mower</li> </ul>
Channel liner	<ul style="list-style-type: none"> <li>• Used for channels with occasional water flow that cannot be diverted</li> <li>• Erosion checks of fiberglass: 50 ft apart on sandy soils, 100 ft apart on heavier soils, and at gradient changes</li> <li>• Erosion checks must be flush with surface</li> <li>• Paper netting at sites with little flow</li> <li>• Installation by experienced persons only</li> </ul>	<ul style="list-style-type: none"> <li>• Routine inspection and replacement if necessary</li> </ul>
Low-flow channel	<ul style="list-style-type: none"> <li>• Riprapped subgraded ditch for constant flow (spring, seepage, etc.)</li> <li>• Grass on waterway sides</li> <li>• Jute or Enkamat liner</li> </ul>	<ul style="list-style-type: none"> <li>• Replace missing or damaged stone areas to original protection levels</li> </ul>
Riprap	<ul style="list-style-type: none"> <li>• Uses filter cloth for soils with poor structure or seepage areas with settling to keep uniform gradient of stone</li> <li>• Used when either low-flow channel or entire channel is riprapped</li> </ul>	<ul style="list-style-type: none"> <li>• Remove bridges or obstructions created by foreign objects to avoid ponding</li> <li>• Check for loose stones from frost heave in spring</li> </ul>
Mattress (Maccaferri)	<ul style="list-style-type: none"> <li>• Use when riprap is being carried away by flow</li> <li>• Flexible for lining channel</li> <li>• Use filter cloth underneath mattresses</li> <li>• Gabions and weirs used for de-energizing</li> <li>• Recommended in place of riprap where removal of stones by public is potential problem</li> <li>• Plastic-treated mattress needed where water contains salt or caustic materials</li> </ul>	<ul style="list-style-type: none"> <li>• Requires least maintenance and has longest life of all linings</li> <li>• Soil will eventually cover mattress and waterway will revegetate</li> </ul>
Concrete	<ul style="list-style-type: none"> <li>• Monolithic reinforced</li> <li>• Energy dissipators needed</li> <li>• Not suitable for acid flow</li> <li>• Not recommended for critical areas</li> <li>• Expensive, last resort</li> </ul>	<ul style="list-style-type: none"> <li>• Check for water underneath channel</li> <li>• Check for voids under and around channel</li> <li>• Watch for undermining from seepage underneath waterway</li> </ul>

**Table 1.10. Maximum permissible design velocities for stable grass-lined channels  
(Source: USDA, SCS 1975)**

Cover	Range of channel gradient, %	Permissible velocity, fps
1. Bermudagrass	0 to 5.0	6
Reed canarygrass		5
Tall fescue		
Kentucky bluegrass		
Grass legume mixture		4
Red fescue		2.5
Redtop		
Sericea lespedeza		
Annual lespedeza		
Small grain (rye, oats, barley, millet)		
Ryegrass		
2. Bermudagrass	5.0 to 10.00	5
Reed canarygrass		4
Kentucky 31 in. tall fescue		
Kentucky bluegrass		
Grass legume mixture		3
3. Bermudagrass	Over 10.0	4
Kentucky bluegrass		3
Reed canary grass		
Tall fescue		

## Outlets

Each diversion must have a stable outlet constructed and stabilized prior to the operation of the diversion. The outlet may be a natural or constructed waterway, a stabilized open channel, a grade stabilization structure, a sediment trap or basin, a level spreader, or any of a variety of down-drain structures. In all cases, the diversion must discharge into the outlet in such a manner as not to cause erosion.

## Stabilization

Once construction is completed, stabilization of the soil surface must be accomplished as soon as possible. Vegetative covers should be established as soon as possible. If anticipated velocities are greater than six fps, a non-vegetative material such as riprap lining should be considered.

## Maintenance

Diversion structures should be inspected approximately every two weeks and after every substantial storm event. Repairs should be made whenever necessary. Sediment removal from the ditch line should be made when necessary to maintain the discharge capacity of the structure. A vegetative cover that has failed to establish or has otherwise failed should be promptly reseeded and mulched (see Table 1.10).

**Table 1.11. Permissible velocities for earth-lined channels (Source: Soil & Water Conservation Engineering, Schwab et al., & American Society of Civil Engineers)**

Soil types	Permissible velocity, fps
Fine sand (non-colloidal)	2.5
Sandy loam (non-colloidal)	2.5
Silt loam (non-colloidal)	3.0
Alluvial silts (non-colloidal)	3.5
Ordinary firm loam	3.5
Fine gravel	5.0
Stiff clay (very colloidal)	5.0
Graded, loam to cobbles (non-colloidal)	5.0
Alluvial silts (colloidal)	5.0
Cobbles and shingles	5.5
Graded, silt to cobbles (colloidal)	5.5
Coarse gravel (non-colloidal)	6.0
Shales and hard pans	6.0

## Erosion Control Measures

In selecting a control measure, a number of items need to be reviewed and evaluated. More than one measure may work effectively, or a measure may be modified to fit a special situation. Each of the control measures will contain the following information: name of control measure, problem identification, design purpose, associated practices, design life, and estimated cost. From this information, the designer can select the control measure that is the most economical, practical, efficient, and adaptable to the site.

Erosion control measures are divided into three categories:

1. Vegetation and soil stabilization erosion control measures
2. Structural erosion control measures
3. Special condition erosion control measures

Individual measures are described in Chapters 2–4.

# CHAPTER 2. VEGETATION AND SOIL STABILIZATION CONTROL MEASURES

## 2.1 GRASS CHANNELS



Figure 2.1. Stream channel (Source: Department of Civil, Construction, and Environmental Engineering, Iowa State University)

### Overview

**Description:** An excavated drainageway to convey runoff through, along, or around the area to be protected; the channel is lined with vegetation to stabilize the surface from erosion. For additional information, refer to Vegetated Channels in Section 1.6.

**Problem identification:** Water runoff must be conveyed across the construction site while retaining sediment that enters or is collected onsite.

**Design purpose:** To convey runoff across the construction site while reducing water velocity and allowing for sediment collection.

**Associated practices:** Used with sediment trapping device if sediment-laden runoff is being diverted; also used with berms and diversions.

**Installation:** When temporary channel grades are steeper than 2.5% to 3.0%, some type of protection is needed to prevent erosion. Depending on the grade, some of the following protective ditch liners can be used: asphalt, burlap, concrete, excelsior, fiberglass, grass, jute, nylon, plastic sheeting, riprap, and sod. The manufacturers normally include specifications to

indicate the velocities and grades that the product will tolerate. For permanent waterways over 0.005 grade, ditch protection may be needed.

Flow should not exceed four fps.

The waterway and outlet shall be shaped to grade with a uniform cross-section. The waterway shall be stabilized with seed, fertilizer and mulching. Vegetative linings vary in the protection afforded. Erosion in the channel bottom should be graded or corrected to the original grade and covered with a ditch liner, excelsior, sod, or other appropriate material.

**Maintenance/inspection:** Inspect after each precipitation event.

**Design life:** Permanent.

**Estimated cost:** Usually bid as square (100 sq ft): grass range is \$9.80 to \$35.00 (2004) and riprap is \$32.00 per ton (2004).

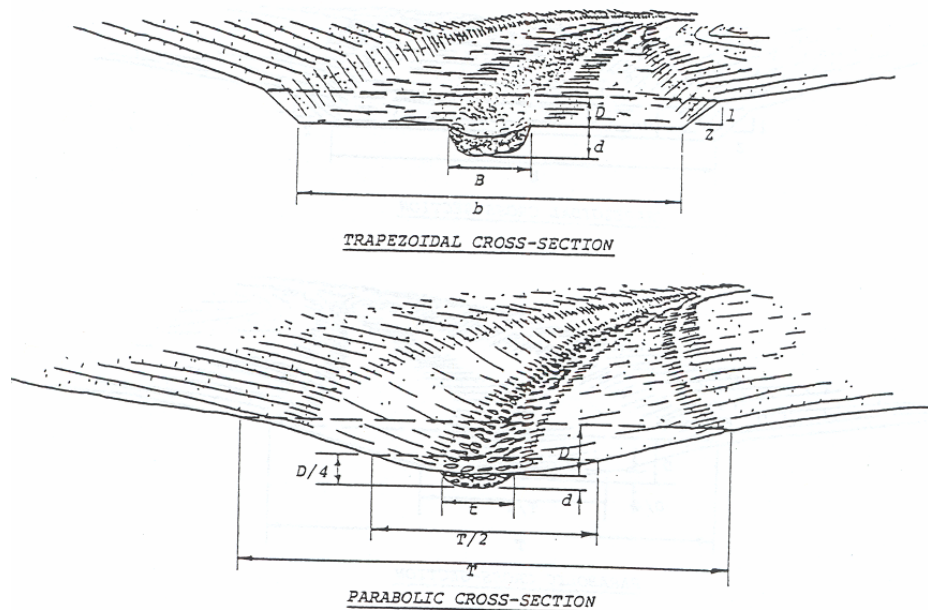
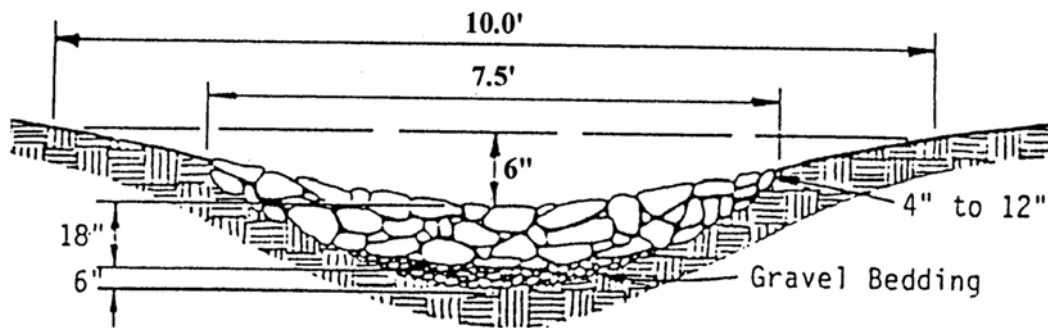

Figure 2.2. Waterway cross section (Source: Omaha Soil Erosion Manual)

## Construction Specifications

1. All trees, stumps, obstructions, and other objectionable material shall be removed and disposed of so as not to interfere with the proper functioning of the waterway.
2. The waterway shall be excavated or shaped to the line, grade, and cross section as required to meet the criteria specified herein and be free of bank projections or other irregularities that will impede normal flow.
3. Fills shall be compacted as needed to prevent unequal settlement that would cause damage in the complete waterway.
4. All earth removed and not needed in construction shall be spread or disposed of so that it will not interfere with the functioning of the waterway.

5. Stabilization shall be done according to the appropriate standards and specifications for vegetative practices.
  - For design velocities of less than 3.0 fps, seeding and mulching may be used for the establishment of the vegetation.
  - For design velocities of more than 3.0 fps, the waterway shall be stabilized with seeding protected by jute, excelsior matting, or with seeding and mulching including temporary diversion of the water until the vegetation is established.



**Figure 2.3. Waterway (Source: Department of Civil, Construction, and Environmental Engineering, Iowa State University)**

## Instructions for Figure 2.4

Wood excelsior matting is one example of special ditch control. Materials and methods for installation shall conform to current standard specifications and to specifications as directed by the engineer. Other mat-type materials may be considered by the engineer for this purpose.

The wood excelsior mat shall be subject to approval by the engineer at the job site. Approval of the final project constitutes approval of the material.

At locations where silt conditions require shaping of a ditch to provide proper types of area for installing the wood excelsior mat for special ditch control, the necessary excavation shall be done by the contractor.

All excavated material should be used to fill low areas, gullies, backslope scours, and otherwise facilitate the free flow of surface water into the channel as directed by the engineer. Alignment should be smooth and abrupt changes should be avoided.

At locations where erosion has created gullies in ditches or backslopes, the gullies shall be filled and compacted in lifts not more than eight inches.

The wood excelsior mat shall comply with the following minimum requirements:

- The mat shall have interlocking wood fibers with plastic netting applied to both sides to hold the excelsior in place.

- The mat shall be nontoxic to the growth of plants and germination of seeds.
- The mat shall be furnished in rolls as follows:
  - Width of strips: minimum 48 in.
  - Length of rolls: minimum 180 ft
  - Minimum weight per sq yd: 0.88 lbs

The netting applied to both sides of the mat shall have a mesh size approximately 5/8 in. by 3/4 in. Netting shall be polypropylene and black in color. The material shall be furnished in plastic bags or otherwise protected to prevent damage from handling and weather conditions.

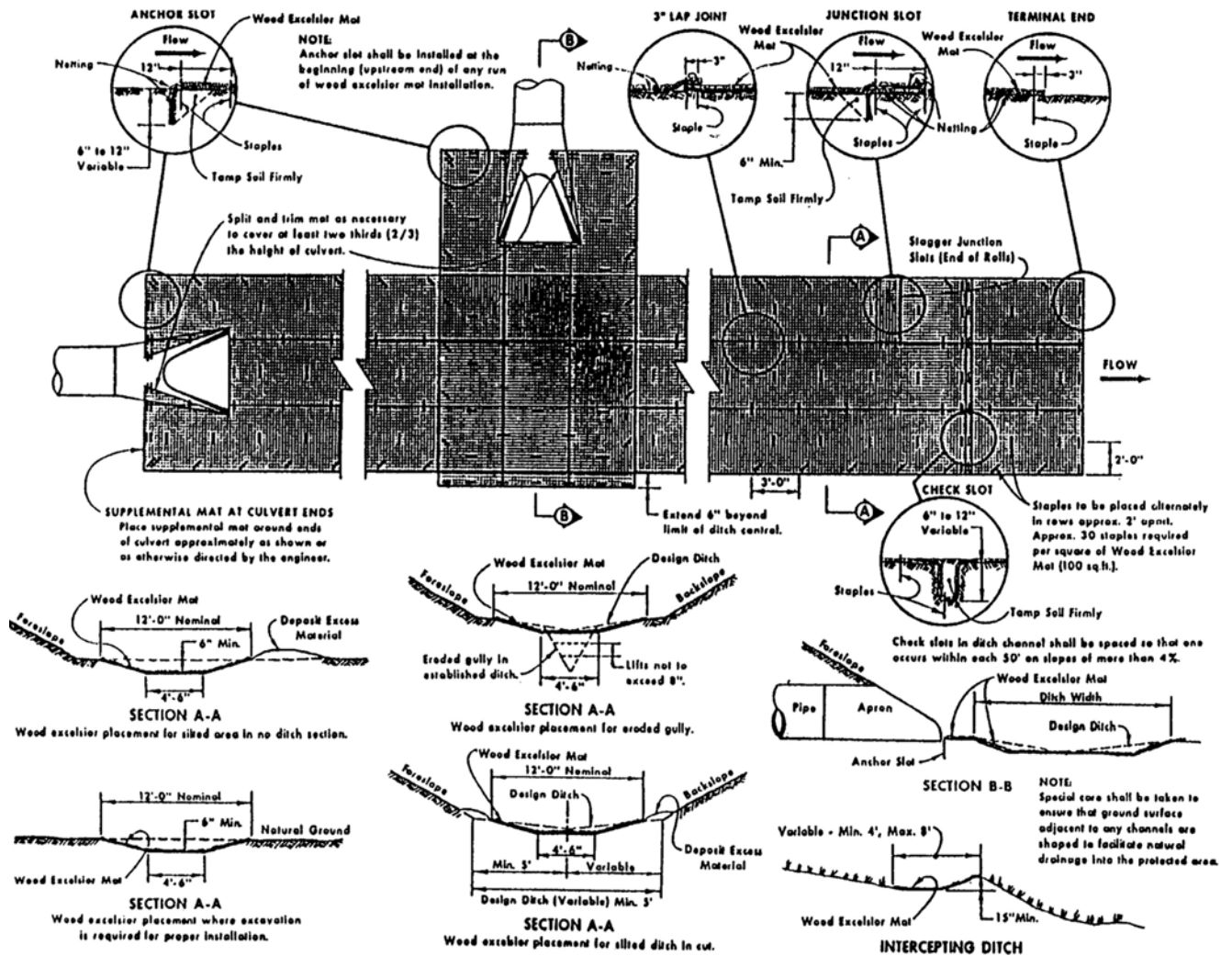

Figure 2.4. Special ditch control (Source: Department of Civil, Construction, and Environmental Engineering, Iowa State University)



## 2.2 DUST CONTROL



**Figure 2.5. Truck-mounted dust-control applicator**  
(Source: [http://soiltac.com/Photo\\_Gallery.html](http://soiltac.com/Photo_Gallery.html))

### Overview

**Description:** A chemical product applied to the exposed soil surface to prevent the movement of dust that may be harmful to human health.

**Problem identification:** Fugitive dust becomes airborne by wind or by vehicle movement due to construction site areas that are devoid of vegetation and moisture.

**Design purpose:** To prevent surface air movement of dust from exposed soil surfaces.

**Associated practices:** Becomes a problem when surface vegetation is destroyed and construction begins, with borrows and construction roads.

**Installation:** A number of materials can be used, such synthetic resin, lignosulfanate, or soybean oil. See Table 2.1. In some cases, calcium chloride is used on roads. Other options are temporary seeding, roughening the soil surface, or erecting snow fences or other barriers.

**Table 2.1. Dust control methods—dilution and rates of application**

Adhesive	Water dilution	Nozzle	Rate, gal/ac
Resin emulsion	4:1	Fine	300
Lignosulfanate	1:1	Coarse	1,815
Soybean soil (soapstock)	Undiluted	Coarse	1,210-2,420

**Maintenance/inspection:** Exposed soil must be protected before dust becomes a problem.

**Design life:** Varies with season and treatment, up to several weeks.

**Estimated cost:** \$.03 to \$.07 per sq ft



Figure 2.6. Manual dust-control applicator (Source: [http://soiltac.com/Photo\\_Gallery.html](http://soiltac.com/Photo_Gallery.html))

## 2.3 MULCHING



Figure 2.7. Mulching (Source: [www.usda.gov/stream\\_restoration/newgra.html](http://www.usda.gov/stream_restoration/newgra.html))

### Overview

**Description:** Application of plant residue or other suitable material to the soil surface.

**Problem identification:** The existing soil surface is devoid of vegetation and moisture, causing soil to become airborne and be transported off the construction site due to wind or vehicle movement.

**Design purpose:** To reduce runoff, conserve moisture, and reduce erosion and sedimentation.

**Associated practices:** Used on bare soil with either temporary or permanent seeding; may be used without seeding to protect critical areas; used after grading, in drainage areas, etc.

**Installation:** Many materials can be used for mulching. The most readily available include grain straw, hay, wood chips or bark, wood cellulose fiber, wood excelsior, and gravel or crushed rock. For mulch to blend with the soil, the soil should be loosened. Since seedbed preparation requires that the soil be tilled to a depth of three inches, this preparation provides ideal soil surface treatment for the application of mulching. Proper application rates are important. Application rates are as follows:

1. Dry straw: Apply 1.5–2 tons per acre, 70 lbs per 1,000 sq ft. Straw mulching can be applied either by machine or by hand. The straw needs to be anchored to the soil. One method of anchoring is pressing the straw into the soil with a mulching tiller (a machine designed for this purpose), or applying a cutback asphalt tack at 1,200 per acre. Mulching applied at the correct rate will allow approximately 50% of the soil to be visible.
2. Hay: Apply 2 tons per acre, 90 lbs per 1000 sq ft. The remainder of application is the same as straw.
3. Wood chips or bark: Apply 10 to 12 tons per acre. This can be applied by machine or by hand. The material decomposes slowly, and it is good, long-lasting mulch.

4. Wood cellulose fiber: Requires 1,000 to 1,200 lbs per acre. The fiber must be applied with a hydroseeder. Mulching must be applied after the seed and fertilizer have been incorporated into the soil.
5. Wood excelsior: Apply at rate of 2 tons per acre. This material lasts longer than straw and is free of weeds. It can be applied by machine or by hand. Like straw, it should be incorporated into the soil.
6. Crushed rock or gravel: Apply at rate of 40 cu yds per acre or 1.5 cu yds per 1000 sq ft. The recommended size is three-fourths to one in. These specifications will result in rock mulching being placed one rock thick, and 50% of the soil should be visible. This is excellent mulching for short slopes or areas that will be subject to light traffic. It may also be placed over black plastic to control weeds.

***Maintenance/inspection:*** Inspect after heavy storm runoff. Look for small areas of erosion or where the mulch has washed away. All areas of failure should be repaired at once.

***Design life:*** Varies, three months to one year.

***Estimated costs:*** Unit cost is dependent on local material costs.

## 2.4 SEEDING AND FERTILIZING



Figure 2.8. Seeding and fertilizing (Source: Iowa DOT)



Figure 2.9. Grain drill seeding (Source: Department of Civil, Construction, and Environmental Engineering, Iowa State University)

## Overview

**Description:** Establishment of grasses and or legumes on disturbed areas. Note: A ground cover of grass is the most effective method for controlling erosion.

**Problem identification:** To reduce erosion and sedimentation. Bare areas of soil exposed to the elements contribute sedimentation and dust.

**Design purpose:** To reduce erosion and damage to downstream resources and improve the soil for permanent plantings.

**Associated practices:** Applies to all disturbed areas devoid of vegetation, unless a specific reason causes vegetation to be inappropriate, such as in protecting slopes, waterways, etc.

**Installation:** Effective reduction in erosion can be achieved by either temporary or permanent seeding. Temporary seeding is short-lived and will lose its effectiveness in six to nine months. The procedure for temporary seeding will be addressed first.

When it becomes evident that a disturbed area in a construction site will not be disturbed for 21 days, it shall be seeded before day 14. However, if excavated material is present, the disturbed area should be seeded or surrounded by a silt fence.

### Temporary Seeding

1. Prepare seedbed to a depth of three in. Before final preparation, apply 400 lbs of 13-13-13 fertilizer per acre (10 lbs per 1,000 sq ft) and incorporate it into the seedbed.
2. Roll the area to be seeded with an approved cultipacker.
3. Apply seed with an approved seeder.
4. Roll the seeded area. If the seeded area is relatively flat, the seeding operation is completed.
5. Mulching will be beneficial if the seeded area is steeper than a 3:1 slope or faces south or southwest. The rate of application is 1.5 tons per acre (70 lbs per 1,000 sq ft).
6. Till the mulched area with a mulching tiller.

If a hydroseeder is used to apply hydromulching, it must be applied at the rate of 2,000 lbs per acre and as the final operation. It is not permitted to apply seed and fertilizer with the mulching.

There are several types of temporary seeding:

- Perennial ryegrass, 40 lbs per acre (1 lb per 1,000 sq ft)
- Oats, 48 lbs per acre (1.2 lbs per 1,000 sq ft). Plant March 1 to May 20.
- Sudangrass, 35 lbs per acre (0.8 lb per 1,000 sq ft). Plant May 21 to August 14.
- Winter rye, 64 lbs per acre (1.6 lbs per 100 sq ft). Plant August 15 to September 30.

### Permanent Seeding

1. Prepare seedbed to a depth of 3 in. Before final preparation, apply 700 lbs of 13-13-13 fertilizer per acre (12 lbs per 1,000 sq ft).
2. Roll seedbed with an approved cultipacker.
3. Apply seed with an approved seeder.
4. Roll seedbed.
5. Apply mulching uniformly at rate of 1.5 tons per acre (70 lbs per 1,000 sq ft).
6. Till all areas mulched on the contour with a mulching tiller.

There are several types of permanent seeding:

- Lawn grass mixture, 80 lbs per acre (2 lbs per 1,000 sq ft): bluegrass 60%, perennial ryegrass 20%, creeping red fescue 15%, and white dutch clover > 5%.
- Tall grass mixture, 40 lbs per acre, (1 lb per 1,000 sq ft): Ky 31 fescue 50%, switchgrass 10%, orchardgrass 20%, bromegrass 15%, and alsike clover 5%.

***Maintenance/inspection:*** Inspect once a month and note the stand of grass; look for areas where runoff water may have caused rills to form or where lack of moisture may have caused seedlings to die. All areas showing stress should be corrected. It may be necessary to reprepare the seedbed, reseed, and remulch.

***Design life:*** Temporary seeding varies by season; permanent seeding is permanent.

***Estimated costs:*** Temporary seeding: \$233 per acre.  
Mulching: \$350 per acre.  
Permanent seed, fertilizer, and mulching: \$945.00 per acre.

## 2.5 SILT FENCE



Figure 2.10. Silt fence (Source: Iowa DOT)

### Overview

**Description:** A temporary barrier of geotextile fabric (filter fabric) used to intercept runoff from small drainage areas of disturbed soil to allow the sediment to settle out of the runoff water. Silt fences are one of the most convenient control measures to use on all projects that involve soil disturbance.

**Problem identification:** Exposed soil areas are subject to water erosion and sediment movement during and after storm water events. Materials and methods are required to eliminate soil loss or movement of soil across construction sites from such events.

**Design purpose:** To trap sediment from sheet flows before it leaves the construction site. Silt fences are effective in trapping sediment from all activities that involve soil disturbance. The fences can be used on adjacent properties, adjacent bodies of water, large sloping areas, near streams and waterways, and near surface drainageways.

**Associated practices:** Used in conjunction with silt traps and basins, temporary seeding, and ditch checks to limit the amount of sediment that approaches the silt fence.

**Installation:** Tables 2.2 and 2.3 show the suggested spacing on slopes and in ditches that contribute runoff to a silt fence area.

Table 2.2. Silt fence spacing on slopes

Slope	Placement interval, ft
3:1 (33%)	40
4:1 (25%)	50
5:1 (20%)	60
10:1 (10%)	100
≤ 50:1 (2%)	150



**Table 2.3. Silt fence spacing in ditches**

Ditch grade, %	Approximate spacing, ft
1-2	150
2-4	75
4-6	40
>6	25

The maximum drainage area flow to a silt fence should not exceed 1/4 acre per 100 ft of fence. Most erosion will occur in the form of sheet erosion, with no concentrated water flow to the fence.

Silt fences should be placed as close as possible to the undisturbed soil.

All filter fabric shall comply with the specifications set forth by the Iowa Department of Transportation.

Steel posts must be used.

Note other control measures, filter strips, and inlet protection.

**Maintenance/inspection:** Inspect once a week and after each rainstorm; look for undercutting and failures in fabric. Clean and dispose of sediment as necessary; repair water damage and fabric failures at once.

**Design Life:** Until sediment accumulates to one-half the height of the fence.

**Estimated cost:** Silt fence: \$2.80 per linear ft.

## Instructions for Figures 2.11 and 2.12

The following details describe various methods of silt fence construction that may be required for the control of siltation on a project. The contractor shall be responsible for accomplishing the required silt fence construction work on the project in such a manner as to effectively minimize and control the water pollution that might be caused by soil erosion from the project. These features are intended to be maintained in appropriate functional condition from the initial construction stages to completion of project.

In addition to the details shown in Figure 2.11 and Figure 2.12, other provisions for controlling erosion may be incorporated into the project work.

Steel line posts for the field fence (T-section), exclusive of an anchor plate, shall weigh not less than 1.3 lbs per ft.

All compaction of backfill shall be performed with a mechanical tamper or pneumatic tamper. All compacting equipment shall be operated according to the manufacturer's recommendations.

## Installation Notes (numbers match those on Figures 2.11 and 2.12)

1. Secure top of geotextile fabric to steel post (see detail of attachment to post).
2. Fold engineering fabric across the bottom of the trench.
3. Make vertical cut in top fold area of fabric. Pull out and twist cord.
4. Loop cord around post to form a loop. Pull wire through fold area of fabric and secure around post.
5. Steel post to be embedded 28 in. below trench bottom.
6. Minimum trench size should be 12 in. deep by 4 in. wide; compact the backfill.

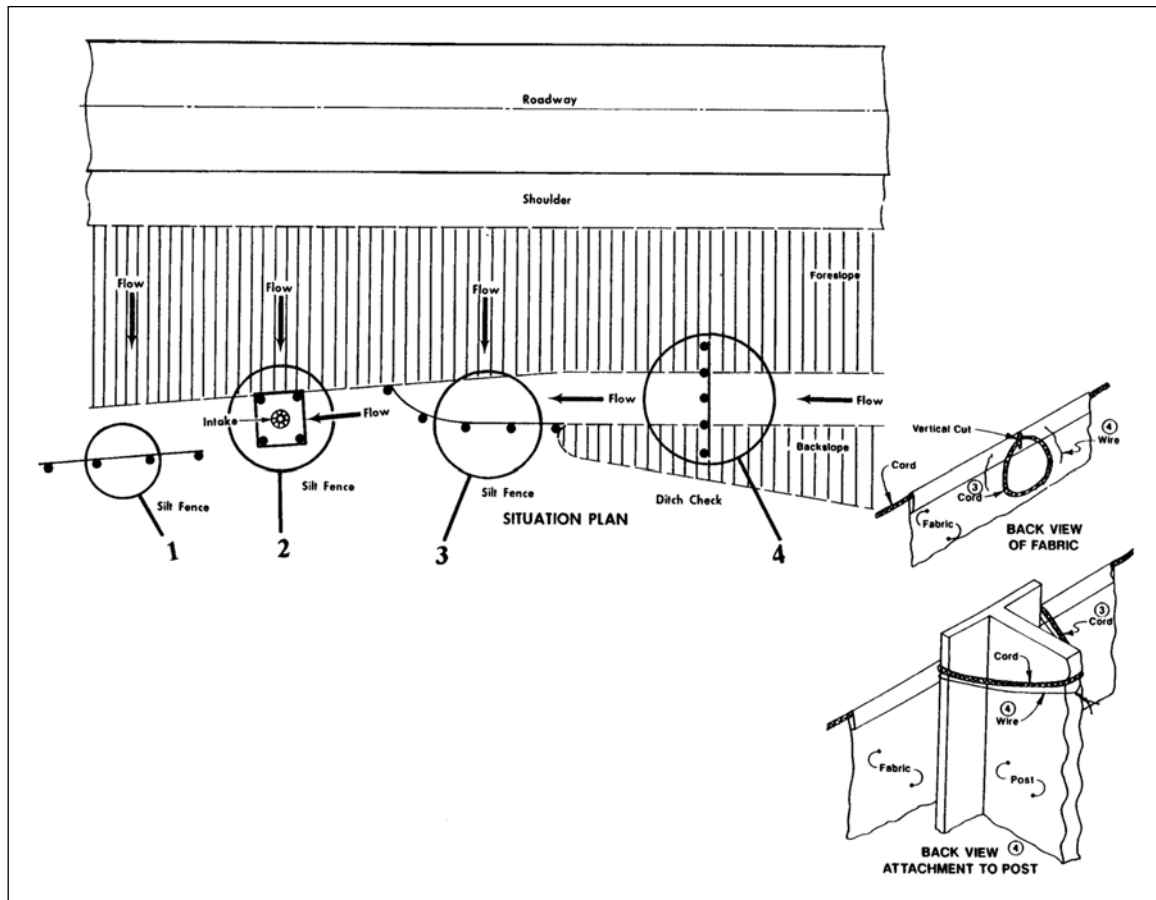

Figure 2.11. Silt fence situation plan (Source: Department of Civil, Construction, and Environmental Engineering, Iowa State University)

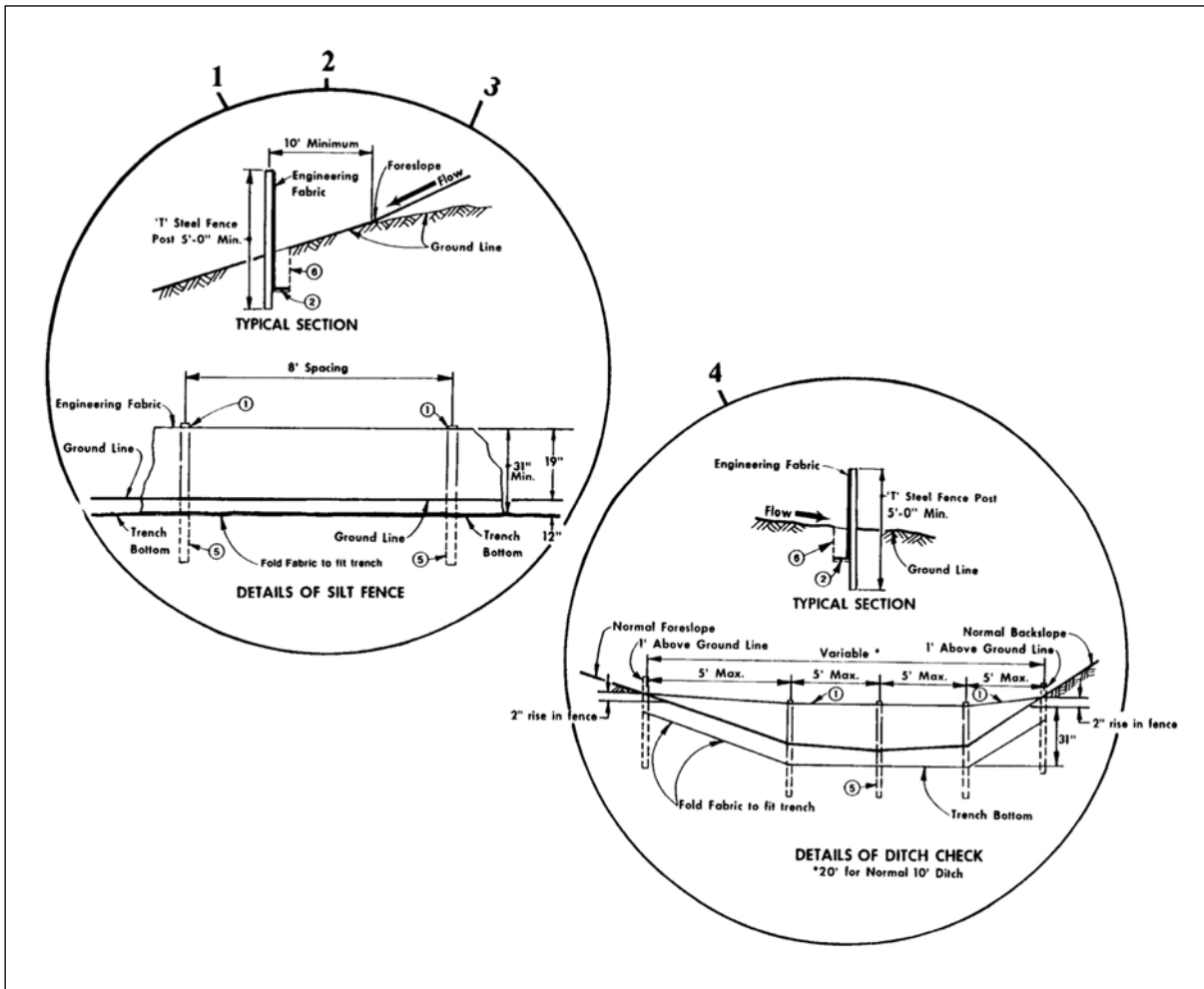

Figure 2.12. Enlargements of number elements in Figure 11 (Source: Department of Civil, Construction, and Environmental Engineering, Iowa State University)



Figure 2.13. Improper silt fence installation (Source: Minnesota DOT)



Figure 2.14. Proper silt fence installations (Source: Iowa DOT)

## 2.6 SODDING



Figure 2.15. Sod truck (Source: Urban Resources and Borderland Alliance Network)

### Overview

**Description:** To cover bare soil with cut sod, usually bluegrass, to provide rapid stabilization of the soil.

**Problem identification:** Waterways, rock chutes, flumes, and some slopes require rapid vegetation establishment to control soil loss due to wind or water erosion.

**Design purpose:** To control erosion or dust and enhance the area, or to protect rock chutes, flumes, and waterways from erosion with sod.

**Associated practices:** Sod is placed in areas where vegetative cover is needed rapidly.

**Installation:** Sod is usually bluegrass or a mixture of bluegrass and creeping red fescue. Sod may be 12 or more in. wide, 3 or more ft long, and approximately 3/4 of an in. thick.

Sod should be installed within 36 hours of being cut.

The sodbed surface should be smooth and firm and free of all debris or other objects that would interfere with sodding or with the final finish. If the area has been subject to construction traffic compaction, the underlying soil bed should be loosened to a depth of two to three inches to aid in root growth.

Sod placed on slopes 3:1 or steeper should be staked.

Apply fertilizer at the rate of 10 lbs of 13-13-13 fertilizer per 1,000 sq ft before the sod is placed. After the sod is placed, it should be rolled to ensure firm contact with the soil. Immediately after rolling, the sod shall be thoroughly watered so the ground is wet at least 4 in. beneath the sod.

For the first two weeks, the sod should be watered three times a week or every two or three days. Watering must be done so wet soil is present four in. below the sod. For the next two weeks, the sod should be watered twice a week (for example, every three days), and again the ground should be soaked to four in. below the sod.

**Maintenance/inspection:** Inspect on a weekly basis to ensure that there are no dry areas or that the sod has not been damaged by heavy precipitation. If hot, dry weather prevails after 28 days of watering, additional water may be necessary. Any damaged areas of the sod should be replaced. Do not mow until the roots are well established and the sod is firm. No more than one-third of the grass leaf should be removed by the first mowing.

The second application of fertilizer should be applied one month after the sod was installed. Use 8 lbs of 13-13-13 fertilizer per 1,000 sq ft.

**Design life:** Permanent.

**Estimated cost:** Sod and 28-day water period: \$49.00 per 100 sq ft.

### Instructions for Figures 2.16 and 2.17

Grading and shaping may include the removal and disposal of excess earth in order to obtain satisfactory drainage and appearance for the finished work.

Sod channels should be constructed at the low point through ditches or borrow areas. All excavated material should be wasted to fill low areas and otherwise facilitate the free flow of surface water into the channel. Alignment should be smooth. Abrupt changes should be avoided.

At locations where silt conditions require shaping of a ditch to provide a proper area for installing sod for special ditch control, necessary excavation shall be done by the contractor with the excavated material disposed of in adjacent areas at the direction of the engineer.

At locations where erosion has created gullies in ditches or backslopes, the gullies shall be filled and compacted in lifts not more than eight in.

Special care shall be taken to ensure that the ground surface adjacent to any sod channels is shaped to facilitate natural drainage into the sodded area.

Where directed, the contractor will be required to stake the sod in place to minimize erosion damage, with a minimum of 33 stakes per square. Wooden stakes shall be used in sod flumes. Longer stakes may be required for certain soil conditions to properly hold the sod in place.

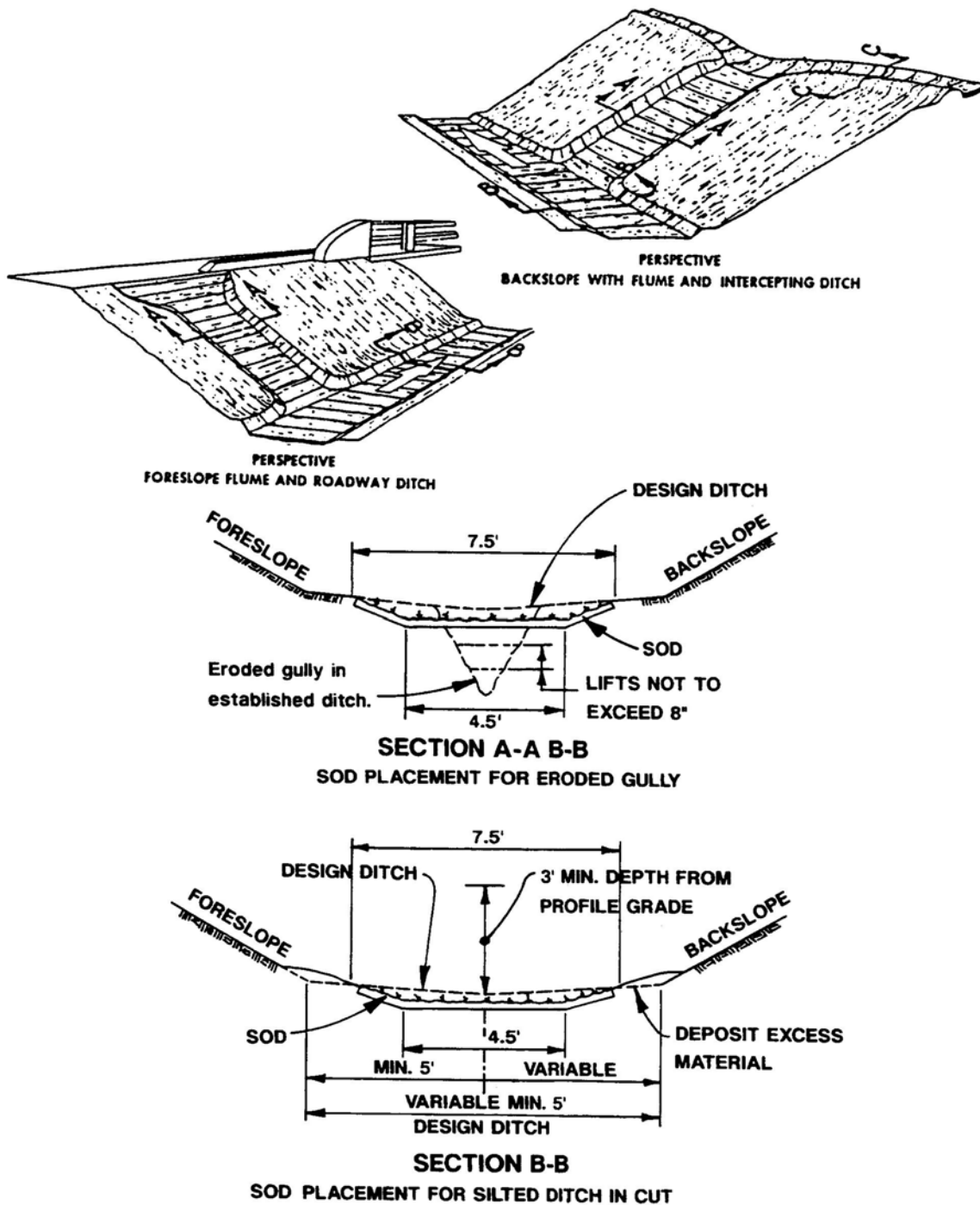

Figure 2.16. Sod placement in eroded gully and silted ditch (Source: Department of Civil, Construction, and Environmental Engineering, Iowa State University)

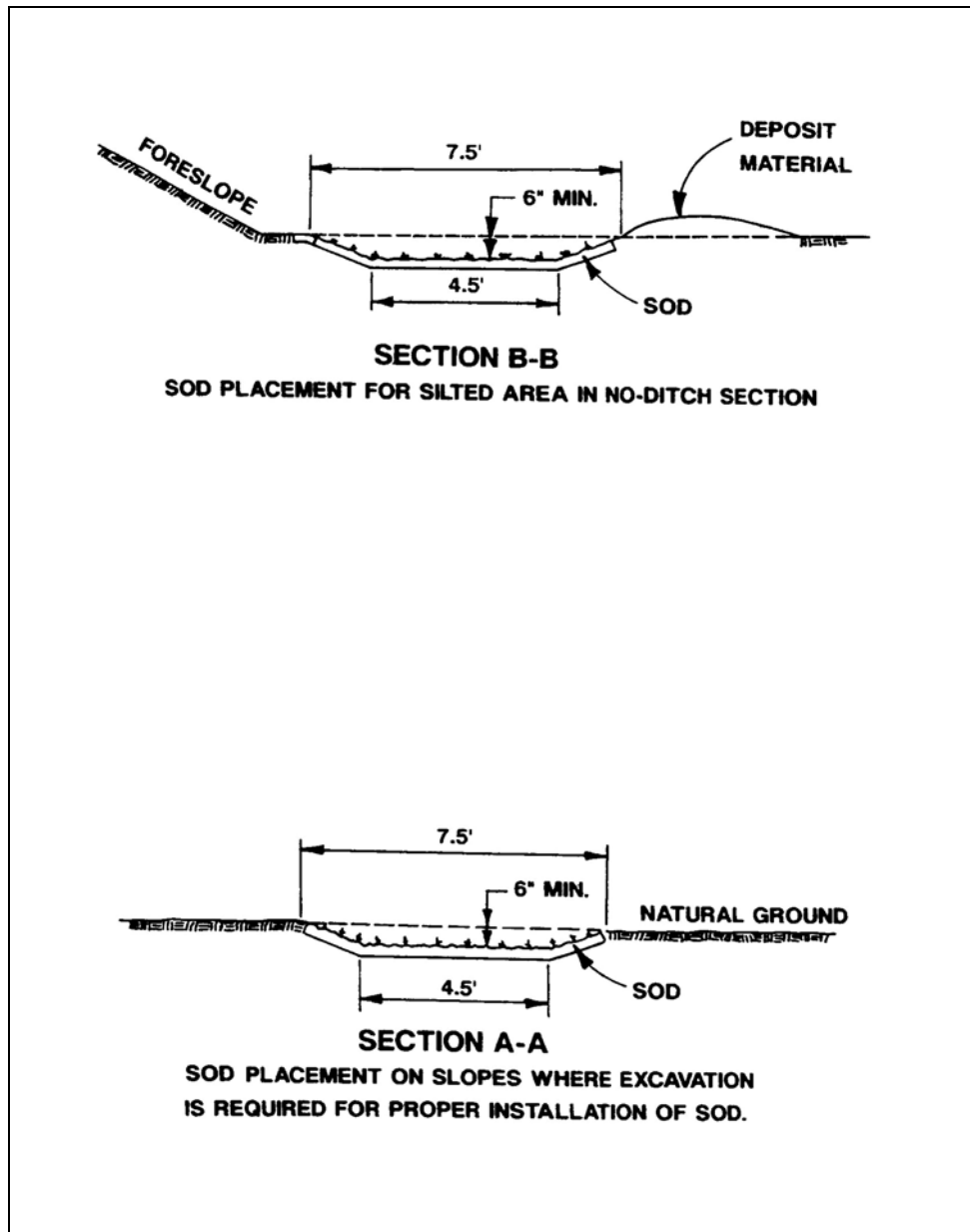

Figure 2.17. Sod placement in no-ditch and slope situations (Source: Department of Civil, Construction, and Environmental Engineering, Iowa State University)



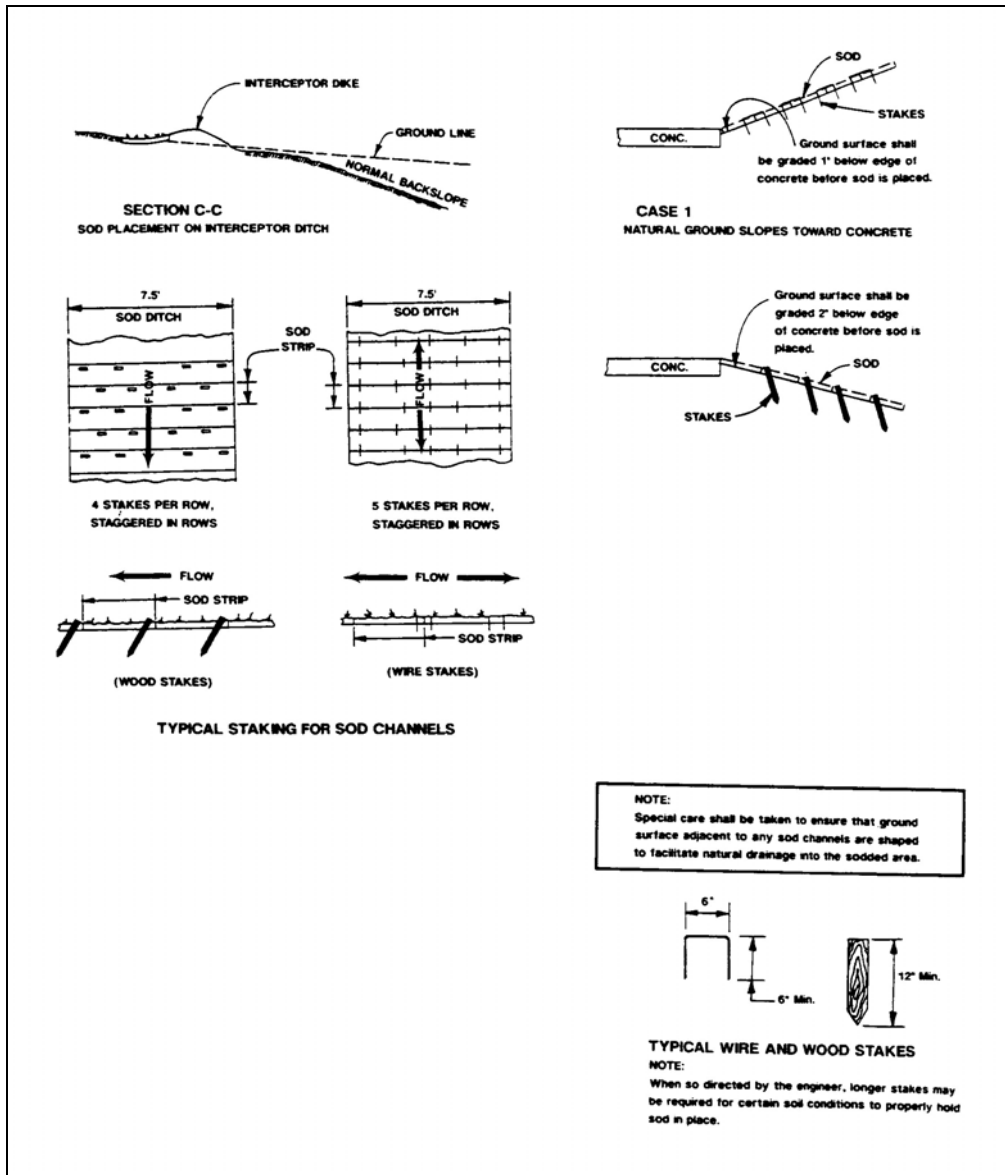

Figure 2.18. Sod staking (Source: Department of Civil, Construction, and Environmental Engineering, Iowa State University)

## 2.7 SURFACE ROUGHENING



Figure 2.19. Surface roughening by disking (Source: Iowa DOT)

### Overview

**Description:** A rough finish on the soil surface with clods three in. across or larger, made by operating a rock disc or other tillage equipment on the contour.

**Problem identification:** During winter months when the soils do not support vegetation, other erosion control measures must be considered.

**Design purpose:** Surface roughening reduces runoff velocity, reduces dust, increases infiltration, reduces erosion, traps sediment, and aids in the establishment of vegetative cover with seed. When a finished, graded area cannot be seeded within 14 days, or if finish grading is completed outside the seeding dates, the area should receive a surface roughening treatment. This method should only be used during the late fall or winter months when seeding cannot be done.

**Associated practices:** Used with slope protection, seedbed preparation, and grading.

**Installation:** All exposed soil areas should be roughened to a depth of four to six in. when the above conditions are present. All equipment movement must be on the contour. It is important that the tillage depth be achieved with one pass of the equipment: it is important not to overwork the soil. Rough surfaces with uneven soil may appear unattractive or unfinished; however, the rough finish encourages water infiltration, speeds the establishment of vegetation, and decreases runoff velocity. This method should be used in clay soils. Areas on which surface roughening has been used should be seeded as soon as weather conditions permit in the next seeding period.

**Maintenance/inspection:** Inspect for erosion damage after severe rainstorms. Look for rivulets and small gullies. Areas of damage may be retilled, or the soil may be reworked and mulched.

**Design life:** Two months in nonfreezing weather; six months in freezing weather.

**Estimated cost:** Tillage: \$49.00 per acre.

## 2.8 VEGETATIVE FILTER STRIP



Figure 2.20. Roadway filter strip (Source: Iowa DOT)

### Overview

**Description:** Grass may be used effectively to control dust, protect soil from erosion, and trap sediment.

**Problem identification:** Water-borne erosion and sediment accumulation can occur in and near natural drainageways and at intermediate locations in sloping soil.

**Design purpose:** To protect soil, improve the visual aspects of the site, and trap sediment.

**Associated practices:** May be used to identify property boundaries and enhance the banks of waterways and channels. Vegetative filter strips also help stabilize the soil and trap silt. Filter strips can be a part of seeding, fertilizing, and mulching control measures, slope grading, etc.

**Installation:** Existing turf should be undisturbed during construction and overseeded with native grasses and forbs to enhance vegetation growth during construction. Refer to the control measure procedure for seeding and fertilizing in Section 2.4. Vegetative filter strips can be installed where a long, flat slope allows sheet flows. A 30 ft wide strip of grass will filter a high percentage of sediment from runoff water. Temporary seeding mixtures should be applied during the construction period, followed by permanent seed mixtures or native grasses.

**Maintenance/inspection:** Inspect on a monthly basis and look for erosion and areas of failure. Repair erosion areas and reseed if necessary.

**Design life:** Permanent.

**Estimated cost:** Fertilizing, seeding, and mulching: \$945.00 per acre.



**Figure 2.21. Vegetative filter strip (Source: [photogallery.nrcs.usda.gov](http://photogallery.nrcs.usda.gov))**



**Figure 2.22. Urban filter strip (Source: Department of Civil, Construction, and Environmental Engineering, Iowa State University)**

## 2.9 COMPOST BLANKETS



Figure 2.23. Blown compost blanket (Source: Iowa Natural Resources Conservation Service 2004)

### Overview

**Description:** A one- to four-inch surface application of compost or mulch or a blend of both to protect areas with erosive potential.

**Problem identification:** Areas disturbed during times when vegetation has difficulty establishing itself need to be protected from erosion and sediment loss.

**Design purpose:** Reduction in the erosion of flat to moderate slopes and in the loss of sediment prior to vegetation establishment.

**Installation:** The materials can be placed at any time during the year. The thickness should be between two to four in., in accordance with the slope and Table 2.4. Generally, the steeper the slope, the thicker the blanket, and coarser compost should be placed on steeper slopes. Place the blanket on the disturbed surface, but do not till into the surface. It is suggested that compost socks be placed at the top of the slope to reduce the velocity of water over the crest of the slope onto the compost blanket. On long slopes or severe slopes (2:1 or greater), slope protection consisting of silt fences or compost filter tubes should be added at spacings not exceeding 25 ft.

Table 2.4. Compost blanket thickness on slopes

Slope	Compost thickness
2:1	4"
3:1	3"
4:1	2"

**Maintenance/inspection:** Blanket areas should be inspected immediately after rainfall, and areas damaged by splash, sheet, or rill erosion should be repaired prior to additional rainfall.

**Design life:** One year.

**Estimated cost:** Cost varies with the availability of the product.

## 2.10 COMPOST FILTER TUBES



Figure 2.24. Compost filter tube (Source: SUDAS Design Manual)

### Overview

**Description:** A mesh sock filled with a blend of compost materials that is used to slow flow velocity, capture and degrade chemical pollutants, and trap sediment.

**Problem identification:** Sloping and disturbed areas require multiple devices to divide the length of the slope into short sections and reduce the flow quantity and velocity of the water. Inlets require methods for collecting sediment before sediment reaches the inlet openings.

**Design purpose:** Multiple purposes, including inlet protection, slope erosion control, perimeter control, and flow diversion.

**Installation:** The particle size must be selected in light of the soil gradations that are to be retained by the device. These devices should be installed along the contour, as with silt fences. Do not place on slopes in excess of a 10% grade. Spacing should be determined to allow the bottom of the next higher tube to be seen from the one being installed below. Place at least five feet from the toe of a slope to provide for the formation of a sediment basin. The tubes should be staked and additional compost placed in front of each tube to enhance the ability to collect sediment.

Tubes placed on slopes should be spaced in accordance with Table 2.5.

**Table 2.5. Maximum compost tube spacing**

Slope	Tube diameter (ft)	
	8"	12" or greater
0% - 2%	75'	125'
2% - 5%	50'	75'
5% - 10%	30'	50'

When used for inlet protection, the tube should be placed in front of the inlet opening and staked behind the curb to hold the tube in place. The tube should be use in conjunction with a mat over the surface openings to prevent sediment from entering the intake.

***Maintenance/inspection:*** Tubes should be inspected immediately after rainfall. Sediment should be removed when the height of the sediment reaches one-third of the tube height. The tube must be replaced or expanded if breached or water finds ways around the tube.

***Design life:*** Six months.

***Estimated cost:*** Varies with the availability of the product.

## 2.11 ROLLED EROSION CONTROL PRODUCTS



**Figure 2.25. Backslope protection (Source: Department of Civil, Construction, and Environmental Engineering, Iowa State University)**



**Figure 2.26. Foreslope protection in growth stage (Source: Department of Civil, Construction, and Environmental Engineering, Iowa State University)**



## Overview

**Description:** Rolled erosion control products (RECP) consist of prefabricated blankets or netting formed from natural and synthetic materials.

**Problem identification:** Steep slopes in urban areas require measures to assist in the establishment of vegetation and reduce the opportunity for erosion of the surface.

**Design purpose:** The RECP materials provide protection to the seed and the underlying soils to reduce the chance of erosion and sediment movement on slopes. RECPs enhance moisture retention to allow for the growth of the seeding applied to the surface. The materials degrade over time and retard unwanted plant growth, reducing maintenance.

**Installation:** The materials should be installed in conjunction with the manufacturer's recommendations. RECPs may be used in channels or on slopes. General recommendations for installation are found in Table 2.6.

**Maintenance/inspection:** Damaged areas should be repaired immediately until the vegetation is established and growing through the material.

**Design life:** Varies with product selection (three to six months).

**Estimated cost:** Varies with the product selected.



Figure 2.27. Wood excelsior mat (Source: North American Green)

**Table 2.6. Typical rolled erosion control product properties and uses\* (Source: Lancaster & Austin 2004)**

Type	Product description	Material composition	Slope applications Max. grade	Channel applications Permissible shear stress*
<b>Ultra short-term: Typical 3-month functional longevity</b>				
1.A	Mulch control nets	Photodegradable synthetic mesh or woven biodegradable natural fiber netting	5:1 (H:V)	0.25 lbs/ft <sup>2</sup>
1.B	Netless rolled erosion control blankets	Natural and/or polymer fibers mechanically interlocked and/or chemically adhered together to form a RECP	4:1 (H:V)	0.5 lbs/ft <sup>2</sup>
1.C	Single-net erosion control blankets & open weave textiles	Processed degradable natural and/or polymer fibers mechanically bound together by a single rapidly degrading synthetic or natural fiber netting or an open weave textile of processed rapidly degrading natural or polymer yarns or twines woven into a continuous matrix.	3:1 (H:V)	1.5 lbs/ft <sup>2</sup>
1.D	Double-net erosion control blankets	Processed degradable natural and/or polymer fibers mechanically bound together between two rapidly degrading, synthetic, or natural fiber nettings.	2:1 (H:V)	1.75 lbs/ft <sup>2</sup>
<b>Short-term: Typical 12-month functional longevity</b>				
2.A	Mulch control nets	Photodegradable synthetic mesh or woven biodegradable natural fiber netting	5:1 (H:V)	0.25 lbs/ft <sup>2</sup>
2.B	Netless rolled erosion control blankets	Natural and/or polymer fibers mechanically interlocked and/or chemically adhered together to form a RECP	4:1 (H:V)	0.5 lbs/ft <sup>2</sup>
2.C	Single-net erosion control blankets & open weave textiles	Erosion control blanket composed of processed degradable natural or polymer fibers mechanically bound together by a single degradable synthetic or natural fiber netting to form a continuous matrix or an open weave textile composed of processed degradable natural or polymer yarns or twines woven into a continuous matrix.	3:1 (H:V)	1.5 lbs/ft <sup>2</sup>
2.D	Double-net erosion control blankets	Processed degradable natural and/or polymer fibers mechanically bound together between two degradable synthetic or natural fiber nettings.	2:1 (H:V)	1.75 lbs/ft <sup>2</sup>
<b>Extended-term: Typical 24-month functional longevity</b>				
3.A	Mulch Control Nets	Slow degrading synthetic mesh/woven natural fiber netting	5:1 (H:V)	0.25 lbs/ft <sup>2</sup>
3.B	Erosion control blankets & open weave textiles	Erosion control blanket composed of processed slow degrading natural or polymer fibers mechanically bound between two slow degrading synthetic or natural fiber nettings to form a continuous matrix or an open weave textile composed of processed slow degrading natural or polymer yarns or twines woven into a continuous matrix.	1.5:1 (H:V)	2.0 lbs/ft <sup>2</sup>
<b>Long-term: Typical 36-month functional longevity</b>				
4	Erosion control blankets & open weave textiles	Erosion control blanket composed of processed slow degrading natural or polymer fibers mechanically bound between two slow degrading synthetic or natural fiber nettings to form a continuous matrix or an open weave textile composed of processed slow degrading natural or polymer yarns or twines woven into a continuous matrix.	1:1 (H:V)	2.25 lbs/ft <sup>2</sup>

\*Refer to SUDAS Manual, Chapter 7, Section 7E-9 (Turf Reinforcement Mats) for additional information on determining shear stress in a channel. Minimum shear stress RECP (unvegetated) can sustain without physical damage or excess erosion (0.5 in. soil loss during 30-minute flow event).

## Instructions for Wood Excelsior Mat as Slope Protection

The work of providing a suitable earth surface for the placement of slope protection shall be considered crucial to preparing the seedbed. Special care shall be taken to ensure that ground surfaces adjacent to any channels are shaped to facilitate natural drainage into the protected area. Seedbed preparation, seeding, and fertilizing shall be performed in accordance with standard specifications. Prior to the placement of wood excelsior matting, the ground shall be uniformly even with the surface of any adjacent concrete.

Excelsior matting for backslope protection is installed with strips placed perpendicular to the roadway. The location for slope protection shall be performed as shown on the detail plan. The excelsior mat for foreslope protection is installed with strips placed parallel to the roadway.

The wood excelsior mat shall comply with the following minimum requirements:

- The mat shall have interlocking wood fibers with a plastic netting applied to both sides to hold the excelsior in place. The mat shall be non-toxic to the growth of plants and the germination of seeds.
- The mat shall be furnished in rolls as follows:
  - Width of strips, min. 48 in., plus or minus 1 in.
  - Length of rolls, min. 180 ft
  - Minimum weight per sq yd, 0.88 lbs

The netting applied to both sides of the mat shall have a mesh size approximately 5/8 in. to 3/4 in. Netting shall be polypropylene and black in color. The material shall be furnished in plastic bags or otherwise protected to prevent damage from weather conditions and handling.

## Directions

1. Space two rows of staples at 18 in. centers, the bottom row at 36 in. centers, and all others staples at 24 in. centers.
2. Where erosive gullies have developed in the backslope, the gullies shall be filled with soil and compacted prior to placement of the mat.
3. There shall be a four feet minimum, an eight feet maximum, or as specified. Place staples the same as is required for special ditch control.
4. Where excelsior mat is to be placed as special ditch control, the slope protection shall be installed to facilitate placement of the ditch control.
5. Foreslope protection shall be four ft, zero in., unless otherwise specified.
6. If an erosive rill has developed adjacent to the shoulder material, it shall be filled with suitable soil and compacted prior to placement of mat.

## 2.12 WATTLES



Figure 2.28. Coconut fiber roll (Source: Natural Resources Conservation Service)

### Overview

**Description:** A sediment velocity control device made of tubes of straw, rice straw, or coconut husk encased in an ultraviolet-degradable plastic netting or 100% burlap material. Wattles help stabilize slopes by breaking up the length of the slope or by slowing and spreading the overland flow of water.

**Problem identification:** Sloping disturbed areas requires multiple devices to divide the length of the slope into short sections and reduce flow quantity and velocity.

**Design purpose:** Provide devices that are biodegradable over time, but that reduce water flow velocities on slopes and allow for sedimentation to remain on the slopes while vegetation is being established.

**Installation:** Wattle locations should be established in the same manner as compost tubes, but are installed in shallow trenches (two to four in. deep). Excavated materials are placed on the upstream side of the wattle to initiate sediment collection. The wattles must be staked with wooden stakes and left in place during the establishment of vegetation on the slope. The size of the wattle should be determined using the Table 2.7.

Table 2.7. Recommended wattle spacing by slope

Slope	Spacing intervals (ft)	
	9" diameter	12" diameter
<4:1	20'	40'
2:1 to 4:1	15'	30'
2:1 or greater	10'	20'

Wattles can be used for inlet protection, but are better suited to slope work.

***Maintenance/inspection:*** To enhance the retention capability of the wattle, sediment should be removed on a routine basis when the level of sedimentation reaches one-half the height of the exposed wattle. Damaged areas should be repaired immediately until the vegetation is established and growing through the material.

***Design life:*** Varies with product selection (three to six months).

***Estimated cost:*** Varies with the product selected.

## 2.13 FLOCCULENTS

### Overview

**Description:** Flocculents are natural materials or chemicals that cause colloidal particles (clay) to coagulate and remove themselves from the water flow in surface runoff.

**Problem identification:** It is difficult to remove large amounts of fine particles from water runoff in a reasonable amount of time.

**Design purpose:** Helps reduce the time of detention in detention ponds and increases the ponds' capacity to handle larger storm runoff quantities in the specified design time.

**Installation:** The flocculent must be added at the time the detention basin is experiencing an inflow of runoff, at a manufacturer-specified rate, and must be mixed constantly with the stormwater. After mixing with the stormwater, the detention pond water must be allowed calm and let the flocculent work. Lastly, the outflow from the basin must be monitored to ensure that the flocculent is removed by settling.

**Maintenance/inspection:** Sediment should be removed on a routine basis to ensure enough volume to receive the sediment. Timing will be based on the amount of ample storage volume to accommodate anticipated runoff. Retention time and sediment storage volume are critical.

**Design life:** Only effective for the volume of water in the detention pond at one time.

**Estimated cost:** Varies with the product selected.

## 2.14 TURF REINFORCEMENT MATS

### Overview

**Description:** Turf reinforcement mats (TRMs) are three-dimensional matting products, constructed from non-degradable synthetic materials or a composite of degradable and non-degradable materials. The matting reinforces the root structure of the vegetation to create a system that can withstand high shear stresses. TRMs are used mainly in channels, ditches, and other high-flow applications in which vegetation alone cannot withstand the erosive forces of the flow.

**Problem identification:** Some existing channels, ditches, and other areas subject to high-velocity flows, such as pipe outlets, require special structural devices to protect the ditch sides and bottom from erosion. Some vegetated channels are required to withstand flow velocities between 10 and 20 fps.

**Design purpose:** Several purposes. Immediately after installation, the TRM provides significant stabilization to the disturbed surface on which it is placed. The mat promotes the growth of vegetation by maintaining consistent moisture and temperature levels. As the vegetation grows down through the mat, the roots become interlocked with the matting, providing a system with a high resistance to erosion.

**Advantages:**

- Withstands high shear stress from flowing water
- Provides permanent, long-term reinforcement of vegetation
- Vegetation creates a more aesthetically pleasing appearance than “hard armor” techniques
- Stabilizes ground where vegetation is difficult to establish
- Usually a less expensive alternative to “hard armor” techniques

**Limitations:**

- With numerous products available, appropriate product selection can be difficult
- Can withstand a limited amount of flow before “hard armoring” is required

**Associated practices:** Used with RECPs, riprap, or other hard armor techniques.

**Installation:** Turf reinforcement mats should be installed in locations where vegetation alone cannot withstand the anticipated flow velocities, where hard armor is not necessary, or where hard armor will be visually unappealing.

Most TRM products are designed and rated for resistance to shear stress. Shear stress in channels lined with TRMs is calculated in the same manner as for grass channels. If the channel is to be vegetated, a variable Manning coefficient will need to be calculated. If the channel is being analyzed for performance with the TRM alone, a constant Manning coefficient provided by the manufacturer may be used.

After calculating the shear stress in the channel, an appropriate TRM that will withstand the anticipated stress can be selected. Many TRM manufacturers provide software to aid in the

calculation of shear stress and the selection of an appropriate TRM. This software may be available through the manufacturer's website or a local product representative.

TRMs should be installed in accordance with the manufacturer's recommendations. The general procedure for TRM installation is to prepare the ground surface, ensuring it is smooth to prevent rilling, followed by seeding and fertilizing, if required. Some manufacturers may recommend placing the mat first, then seeding directly into the mat, followed by spreading a one- or two-inch layer of topsoil over the mat and seed. After ground preparation, the TRM may be placed and anchored with stakes or staples. The manufacturer will provide specifications for the pattern and spacing of anchor stakes or staples, overlap between mats, and any additional product requirements. Installing the appropriate number of staples or stakes is important to prevent "tenting" of the material as the vegetation begins to grow and pushes up on the matting.

When the mat is placed first, followed by seeding and spreading a one- or two-inch layer of topsoil over the mat and seed, a secondary RECP should be placed over the TRM to protect the top layer of soil and seed until the vegetation can become established.

At the beginning of the installation, the product should be trenched in and anchored to prevent water from flowing under the matting. It is also recommended that additional staple barriers or trenches be installed at 25- to 35-foot intervals along the installation to cut off any flow that has developed under the matting and force the flow back on top of the matting.

***Maintenance/inspection:*** Once installed, little maintenance needs to be done to TRMs. If the TRM is to be vegetated, the vegetation should be watered as needed. Until the vegetation is fully established, the ground surface should be inspected for signs of rill or gully erosion below the matting. If there are any signs of erosion, tearing of the matting, or areas where the matting is no longer anchored firmly to the ground, the matting should be repaired.

***Design life:*** Permanent.

***Estimated cost:*** Varies with the size and type of mat materials used in the design.



# CHAPTER 3. STRUCTURAL EROSION CONTROL MEASURES

## 3.1 BENCH



**Figure 3.1. Bench cut, upper level (Source: Department of Civil, Construction, and Environmental Engineering, Iowa State University)**

### Overview

**Description:** Slightly reverse sloping steps, 8 to 10 ft wide horizontally, on a back slope at intervals of 20 to 25 feet in vertical height.

**Problem identification:** The combination of precipitation, steep slopes, and erosive soils can cause sheet and gully erosion.

**Design purpose:** Reduce runoff volume and increase infiltration.

**Associated practices:** Requires provision for runoff disposal and slope protection.

**Installation:** Constructed as a part of the grading operation. As soon as possible, the exposed soil should be fertilized, seeded, and mulched.

**Maintenance/inspection:** The site should be inspected after each precipitation event, both slope areas and down drains from each bench. All problem areas should be repaired as soon as possible; it may be necessary to reseed, remulch, or repair some of the down drains.

**Design life:** Permanent.

**Estimated cost:** Included in grading.



**Figure 3.2. Bench cut, profile view (Source: Department of Civil, Construction, and Environmental Engineering, Iowa State University)**



**Figure 3.3. Bench cut, interchange application (Source: Department of Civil, Construction, and Environmental Engineering, Iowa State University)**

## 3.2 COMPOST FILTER BERMS

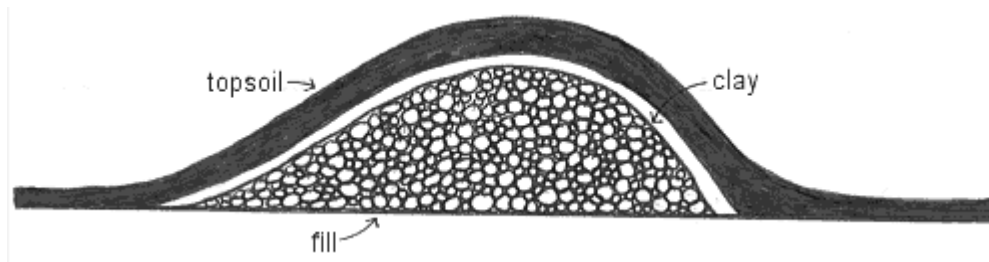

Figure 3.4. Berm (Source: Urban Resources and Borderland Alliance Network)

### Overview

**Description:** A temporary or permanent ridge of soil located in such a manner as to channel water to a desired location.

**Problem identification:** Sheet and gully erosion occurs on slopes where runoff velocities and outlet locations are not controlled.

**Design purpose:** To prevent runoff from going over the top of a cut and eroding the slope; may be used to direct runoff away from a construction site, divert clean water from a disturbed area, or reduce the size of a drainage area.

**Associated practices:** Requires adequate down drains to dispose of runoff when used on slopes.

**Installation:** Compaction of the soil is necessary. The minimum recommended grade is 1%. As soon as the compost filter berm is completed, it should be fertilized, seeded, and mulched. Earth berms shall have an outlet that functions with a minimum of erosion. The runoff shall be conveyed to a sediment trapping device.

Table 3.1. Maximum filter berm spacing for berm size of 1' x 2' (height x width)

Slope	Slope length
0%–2%	125'
2%–5%	75'
5%–10%	50'

**Maintenance/inspection:** Inspect after each precipitation event for erosion. Repairs must be done after each precipitation event. The outlets always need protection. Vegetation provides the best protection.

**Design life:** Six months.

**Estimated cost:** \$2.80 per linear ft for small compost filter berms (2004); \$8.40 per linear ft for large compost filter berms.

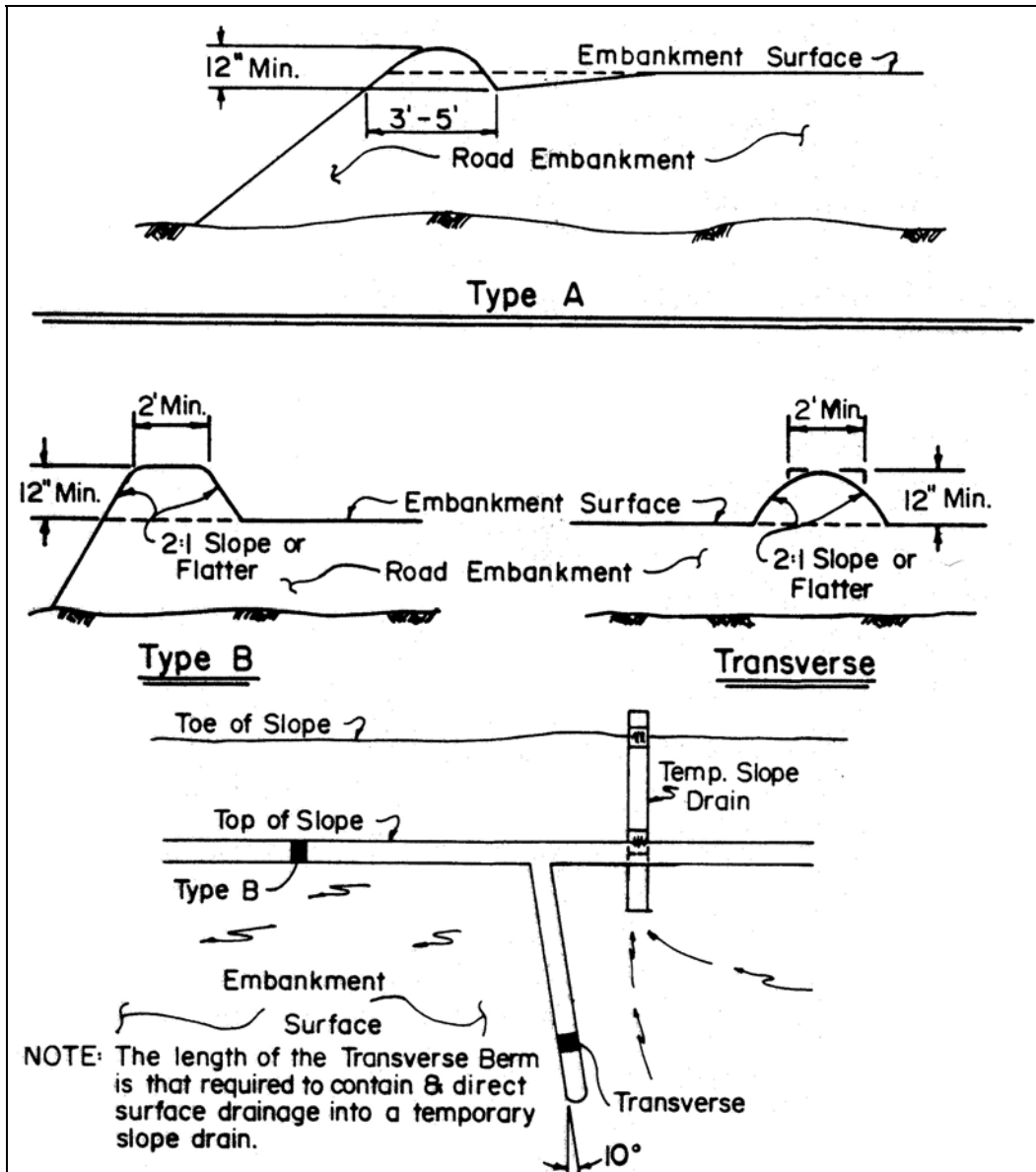

Figure 3.5. Temporary berms (Source: West Virginia DOT)

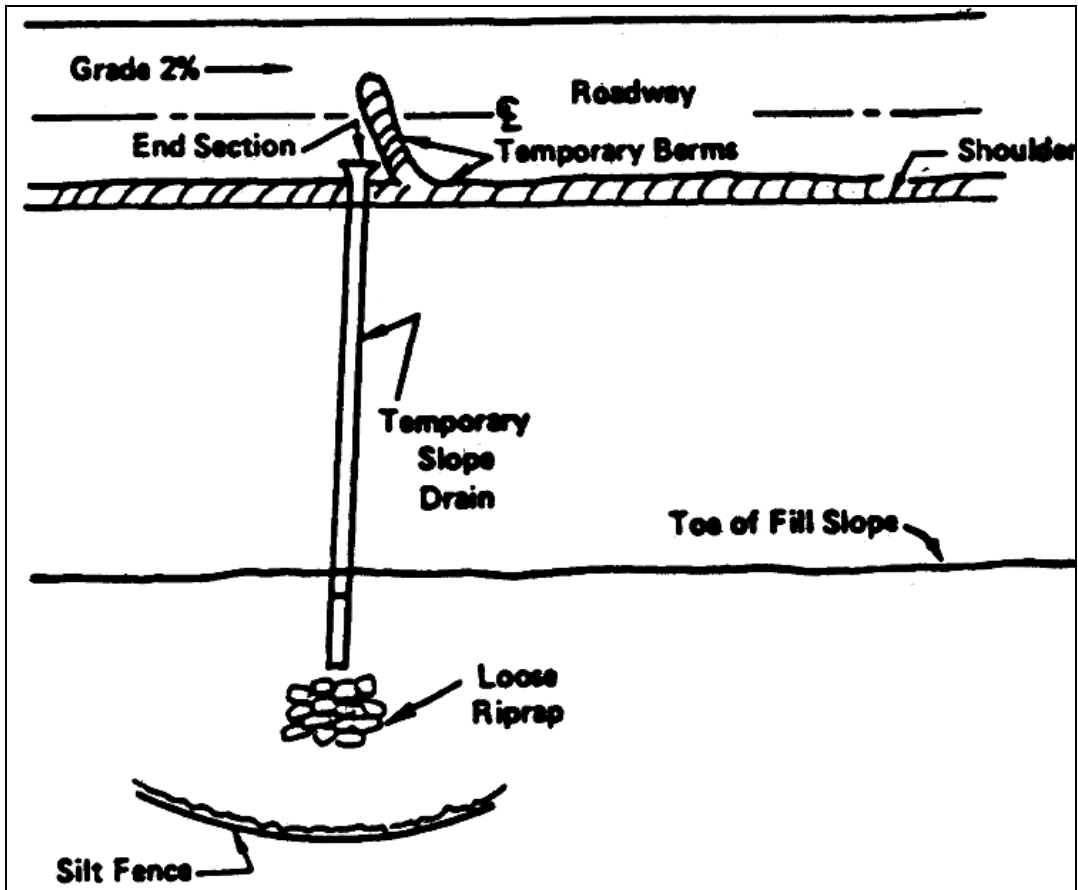

Figure 3.6. Temporary berm and temporary slope drain system (Source: Department of Civil, Construction, and Environmental Engineering, Iowa State University)

### 3.3 CHECK DAM



**Figure 3.7. Check Dam (Source: Department of Civil, Construction, and Environmental Engineering, Iowa State University)**

#### Overview

**Description:** A small, temporary barrier or dam constructed across a drainage ditch.

**Design purpose:** To prevent erosion by reducing the velocity of storm water in areas of concentrated flow and lengthening the detention time.

**Associated practices:** Used as a temporary or emergency measure to limit erosion by reducing the velocity; used with riprap and silt fences.

**Installation:** Several materials can be used. Check dams are constructed by installing selected material at right angles to the direction of flow. Dam height should be 6 in. lower than the outside edge of the channel. Materials that can be used are 5- to 10-inch riprap or silt fences.

**Maintenance/inspection:** Periodic inspection is required. Sediment should be removed when it reaches one half the original dam height. Any material damage to the check dams should be corrected before the next precipitation event.

**Design life:** Stone has a life of one year, maybe permanent; manufactured has a life of six months.

**Estimated cost:** Riprap costs \$25.20 per ton (2004); silt fence costs \$2.80 per linear ft (2004).

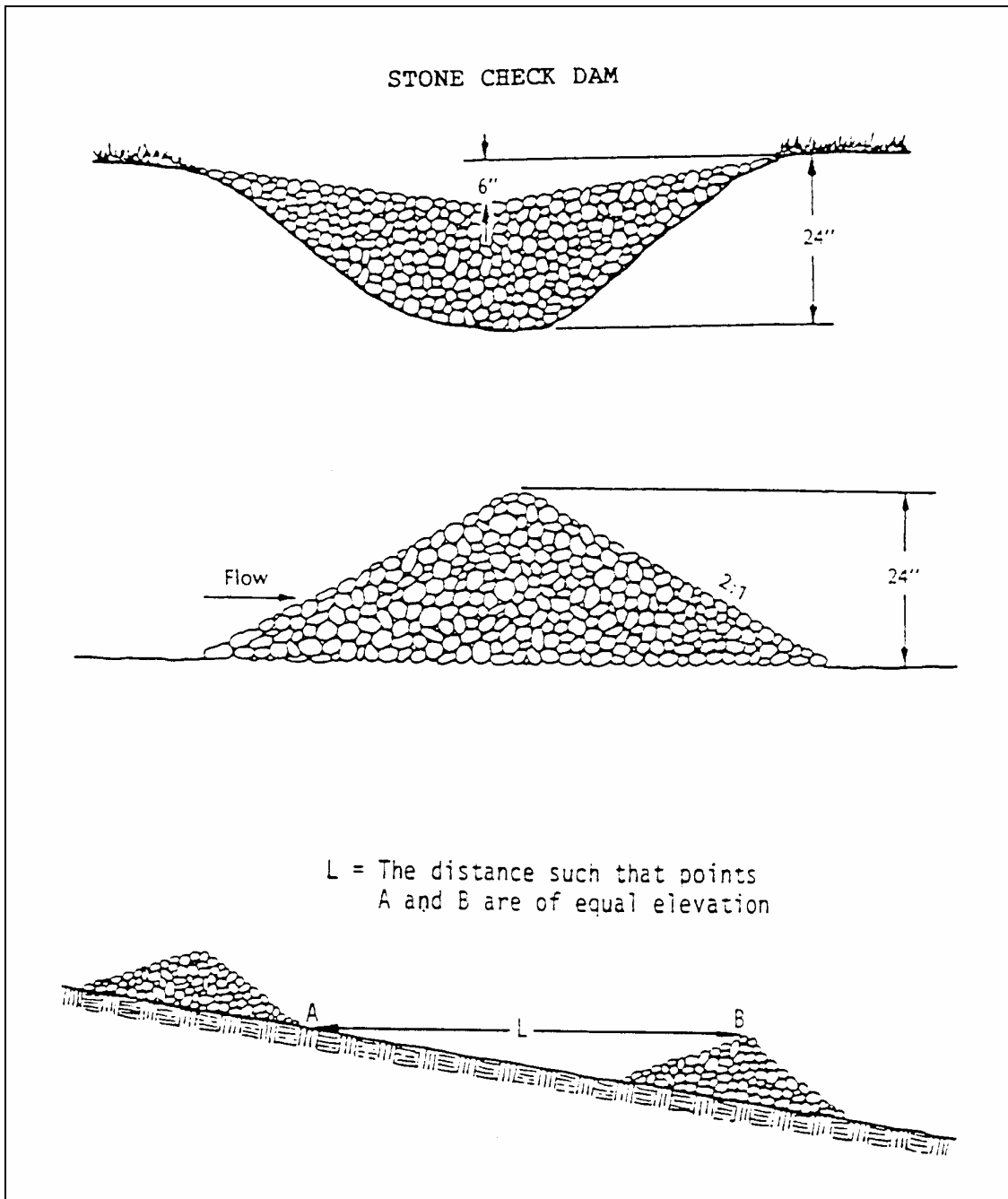

Figure 3.8. Spacing between check dams (Source: Department of Civil, Construction, and Environmental Engineering, Iowa State University)

### 3.4 TEMPORARY SLOPE DRAIN (PIPE OR ROCK)



**Figure 3.9. Temporary slope drain (Source: Department of Civil, Construction, and Environmental Engineering, Iowa State University)**

#### Overview

**Description:** A temporary structure, either metal or flexible pipe, placed from the top of a slope to the bottom of a slope.

**Problem identification:** Limited construction areas, steep slopes, and large drainage areas create a need to control concentrated flows down a slope face.

**Design purpose:** To carry a concentrated flow of runoff water down a slope without causing erosion.

**Associated practices:** May be used on benched back slopes, with diversion structures, or where runoff is conveyed down fill sections.

**Installation:** The slope drains shall have a minimum grade of 3%. The top of the dike shall be at least 1 ft higher than the top of the inlet. All inlets shall be fitted with an apron and attached with a watertight connection. When flexible pipes are used, they shall be securely anchored with grommets placed 10 ft on center. A sediment trapping device may be placed at the outlet if deemed necessary. Riprap may be required at the outlet.

**Maintenance/inspection:** Inspection shall be performed after each storm. All problem areas should be corrected as soon as possible.

**Design life:** Temporary, until vegetation is established.



## 3.5 ENERGY DISSIPATOR



Figure 3.10. Energy dissipator (Source: Iowa DOT)

### Overview

**Description:** An obstacle placed at the outlet of drainage pipes or where a rapid flow of water needs to slow down in order to prevent erosion.

**Problem identification:** Excessive flow quantities and velocities cause erosion at the outlet of drainage structures. Control measures are needed to reduce water velocities at this location.

**Design purpose:** To control erosion and reduce the velocity of runoff water.

**Associated practices:** Used with measures that carry water and sediment; reduces velocity for streambank protection; used at outlets of pipes.

**Installation:** A wide range of materials can be used as energy dissipators, depending on the flow. Lighter to heavier flows can be handled with seeding, excelsior mats, or sod. In more demanding areas, control may be achieved by using riprap, boulders, or gabions. Regular construction procedures must be followed to achieve success.

**Maintenance/inspection:** Review control measure after each precipitation event.

**Design life:** Permanent.

**Estimated cost:** Riprap costs \$32.20 per ton (2004).

## 3.6 FLOTATION SILT CURTAIN



Figure 3.11. Flotation silt curtain (Source: Minnesota DOT)

### Overview

**Description:** A silt barrier for use within a pond or lake. This device consists of a heavy-duty filter fabric that is weighted at the bottom and attached to a flotation unit at the top.

**Problem identification:** When construction occurs near open bodies of water, measures must be taken to retain and remove sediment and floating debris at the water's edge.

**Design purposes:** To isolate a construction area within a pond or lake to prevent silt-laden water from migrating out of the construction area; to limit and control the migration of suspended sediment within a pond or lake.

**Associated practices:** Not used with other control measures.

**Installation:** Flotation silt curtains are divided into three types, Type I, Type II, and Type III, based on the flow conditions within the water body. The information provided here applies to minimal and moderate flow conditions, where the velocity of flow is five fps or less. For situations in which the flow is greater than this, additional investigation is required, and a qualified manufacturer should be consulted.

The three types of silt curtains are differentiated by the strength and flow-through rate of the fabric and by the strength of the connecting materials used.

1. Type I curtains are considered light-duty and are intended for areas where there is no current and where the area is protected from wind and wave action.
2. Type II curtains can be used in areas with moderate running current (up to 3.5 fps) or where the wind and water currents can affect the curtain.

3. Type III curtains are used in areas with considerable current (up to 5 fps) or where the curtain is subject to more severe wind and wave action.

A flotation carrier should be at the top of the curtain. The carrier may be a floating plastic tube 6 in. in diameter and filled with marine-quality polyethylene foam. A 5/16 in. diameter coated steel cable should be centered in the floating tube to carry the weight of the curtain. The bottom of the curtain should be weighted by a chain or cable that weights 1.1 lbs per linear ft. Every 100 ft of the curtain requires a 24 lb anchor. When the curtain is made of more than one section, the sections should be overlapped so that silt cannot migrate through the connection.

**Maintenance/inspection:** Inspect after heavy winds that may create waves; also check anchors and their attachments. Weekly checks should be made on each installation to determine the curtain's condition and the remaining capacity for sediment and debris retention. When the remaining capacity falls below 50% or the vegetation is established adjacent to the curtain, the sediment and debris shall be removed in conjunction with curtain removal. Allow 24 hours for sediment to settle before removing the curtain. Any problem or failure of the curtain must be repaired immediately.

**Design life:** One construction season. Do not leave in place during winter months.

**Estimated cost:** \$28.00 per linear ft.

## 3.7 ROCK CHUTES AND FLUMES



Figure 3.12. Flume (Source: Urban Resources and Borderland Alliance Network)

### Overview

**Description:** A device to carry water in an open structure to a lower level without erosion.

**Problem identification:** Permanent control devices are required to convey runoff along the bottom of slopes without causing erosion and sedimentation. These devices must reduce velocities and maintain discharge.

**Design Purpose:** To carry storm water runoff on a permanent basis without erosion.

**Associated practices:** Used with other control measures to dispose of storm water runoff.

**Installation:** A variety of materials can be used, depending on the volume of water that needs to be transported. For a small volume of water, a sod flume can perform satisfactorily. Other materials include half-round pipe, riprap underlaid with filter fabric, and paved flumes. Each needs to be constructed on firm, well-compacted soil.

**Maintenance/inspection:** All types of flumes need to be inspected after precipitation events for any necessary repairs or adjustments.

**Design life:** Permanent.

**Estimated cost:** Sod costs \$49.00 per square (2004); riprap costs \$32.20 per ton (2004).

## 3.8 GABION



Figure 3.13. Gabion (Source: Modular Gabion Designs)

### Overview

**Description:** Gabions are rectangular wire mesh boxes that are filled with rock. They are used for channel revetments, retaining walls, check dams, bridge abutments, culvert headwalls, and almost any place where a heavy, flexible reinforcement is necessary.

**Problem identification:** Erosion measures are needed on steep banks adjacent to waterways, on buildings where right-of-way is limited, or where erosive soils are present.

**Design Purpose:** To use a material that is strong, flexible, and effective in the control of erosion.

**Associated practices:** For use in waterways, bank stabilization, and areas needing a permeable building block.

**Installation:** The mesh boxes or baskets are available in a wide range of sizes. The gabion is normally filled with four- to eight-inch rock, which usually is dumped mechanically and filled in place. The filled gabion becomes a large, flexible, and permeable building block. The baskets are corrosion-resistant, strong, and durable, and when filled they become flexible blocks from which a wide range of structures can be built.

**Maintenance/inspection:** Periodic inspection should be done to look for signs of undercutting or excessive erosion at the transition areas. Make necessary adjustments for problem areas.

**Design life:** Permanent.

**Estimated costs:** Cost varies with rock material selection and excavation costs

## 3.9 INLET PROTECTION



Figure 3.14. Inlet protection (Source: Minnesota DOT)

### Overview

**Description:** A manufactured protective device or barrier used to trap sediment at a storm drain surface or curb inlet.

**Problem identification:** During grading operations, measures are required to prevent sediment from moving from the work area into surface drains in the pavement curb or from area drains into the work area.

**Design purpose:** To trap sediment carried in stormwater runoff from disturbed areas and to prevent sediment from moving out of the work area.

**Associated practices:** Small basins should be used extensively around earth surface areas during construction and on a day-to-day basis as construction proceeds near where runoff will take place.

**Installation:** A number of practices provide storm drain inlet protection. Ideally, the drainage area is limited to one acre or less. Each practice will be reviewed separately below.

1. Curb drop inlet protection: Wire mesh of sufficient strength to support filter fabric with stone shall be placed so it extends 2 ft beyond the inlet in both directions. The 2-inch-sized stone should be placed against the filter fabric to a depth of 10 to 12 in. To ensure that runoff does not bypass the inlet, install temporary dikes directing the flow into the inlet.
2. Excavated drop inlet protection: The side slopes should be no steeper than 2:1. The excavated basin should be 1–2 ft deep. The basin should be shaped with the longest dimension oriented toward the longest inflow in order to result in maximum trap efficiency. The capacity of the basin should be 900 cu ft per acre. Weep holes protected with filter fabric and stone should be provided for draining the temporary pool.

3. Silt fence drop inlet protection: A 3 ft square frame, reinforced with wire mesh and covered with filter fabric on the sides, should be installed around an intake with the bottom edge sealed. The maximum height of the fabric should not exceed 18 in. Steps must be taken at the site and upstream to prevent water or sediment from overtopping the silt fence.
4. Sod drop inlet protection: Place the sod to form a turf mat completely covering the soil surface for a minimum distance of 4 ft on each side of the intake where runoff water will flow. The slope where the sod is placed should not exceed 4:1. During the first four weeks, the sod should be watered twice a week. The ground should be wet to a depth of 4 in. This method should only be applied in urban areas with a drainage area of less than 1/4 acre.
5. Compost filter tubes: Compost filter tubes can be placed around the perimeter of an area intake or in the throat or around the grate of a curb inlet.
6. Raise inlet of structure to provide a natural silt basin.
7. Keep elevation of fill one ft below inlet flow line.
8. Place silt basin approximately 200 ft ahead of entrance pipes in ditch grades 1% to 2%.

**Maintenance/inspection:** These structures should be inspected after every storm. Any sediment should be removed and disposed of on the site. Any damage should be repaired.

**Design life:** The life of an earth surface inlet protection is estimated to be three to six months, and that of a curb inlet protection is one year.

**Estimated cost:** Silt fence costs \$2.80 per linear ft (2004); crushed rock costs \$15.40 per ton (2004).

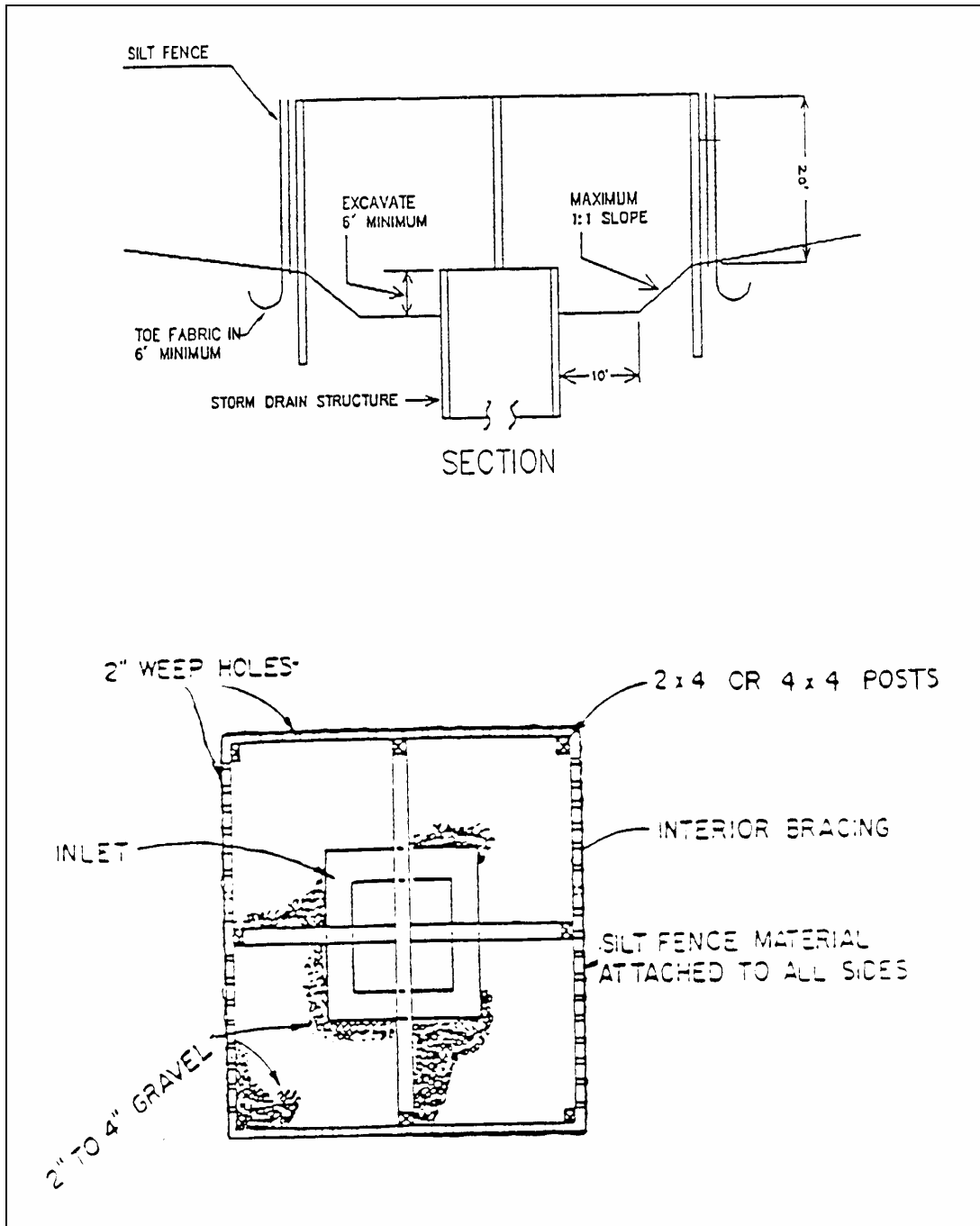

Figure 3.15. Inlet protection diagram (Source: Department of Civil, Construction, and Environmental Engineering, Iowa State University)





Figure 3.16. Inlet sediment control (Source: Department of Civil, Construction, and Environmental Engineering, Iowa State University)

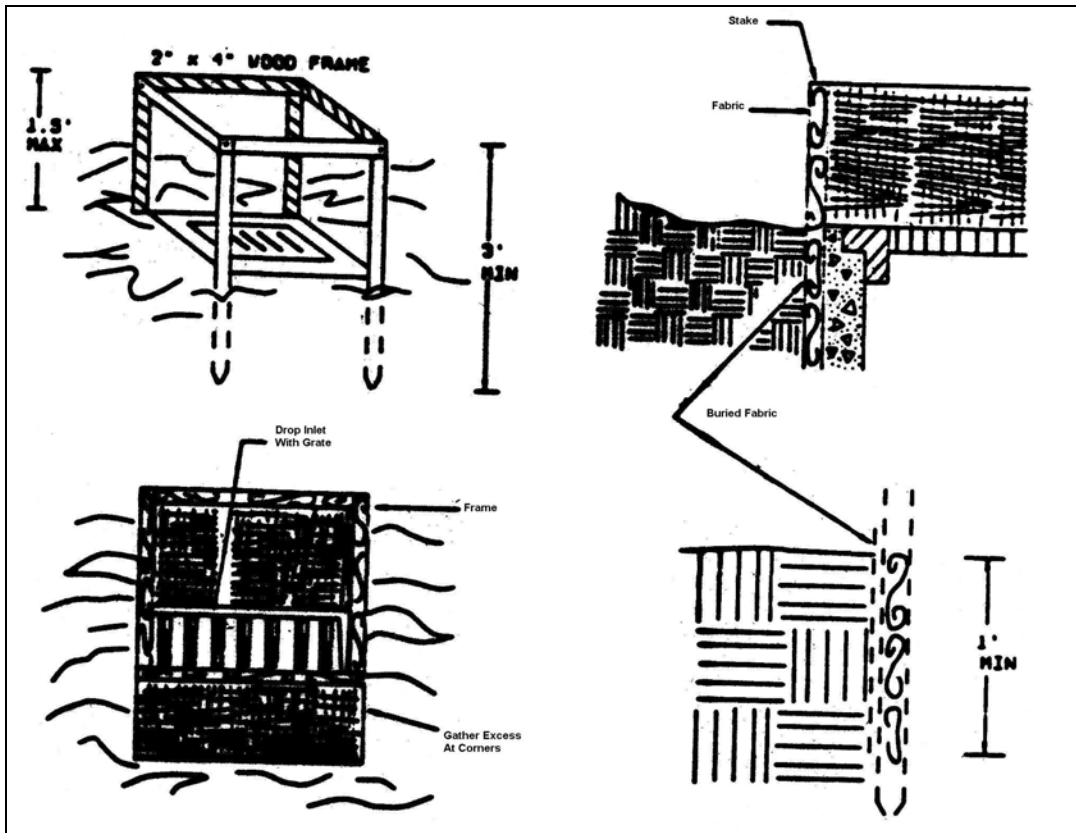

Figure 3.17. Filter fabric drop inlet protection (Source: Department of Civil, Construction, and Environmental Engineering, Iowa State University)

**Construction specifications**

1. Filter fabric or burlap may be used for short-term applications.
2. Cut fabric from a continuous roll to eliminate joints. If joints are needed, they will be overlapped at the next stake.
3. Stake materials will be standard 2 by 4 in. wood or an equivalent. Metal stakes may be used with a minimum length of 3 ft.
4. Space stakes evenly around the inlet 3 ft apart and drive them a minimum of 18 in. deep. Spans greater than 3 ft may be bridged with the use of wire mesh behind the filter fabric for support.
5. Fabric shall be embedded a minimum of 1 ft below ground and backfilled. The fabric shall be securely fastened to the stakes and frame.
6. A 2 by 4 in. wood frame shall be constructed around the crest of the fabric for overflow stability.
7. Maximum drainage area = 1 acre.

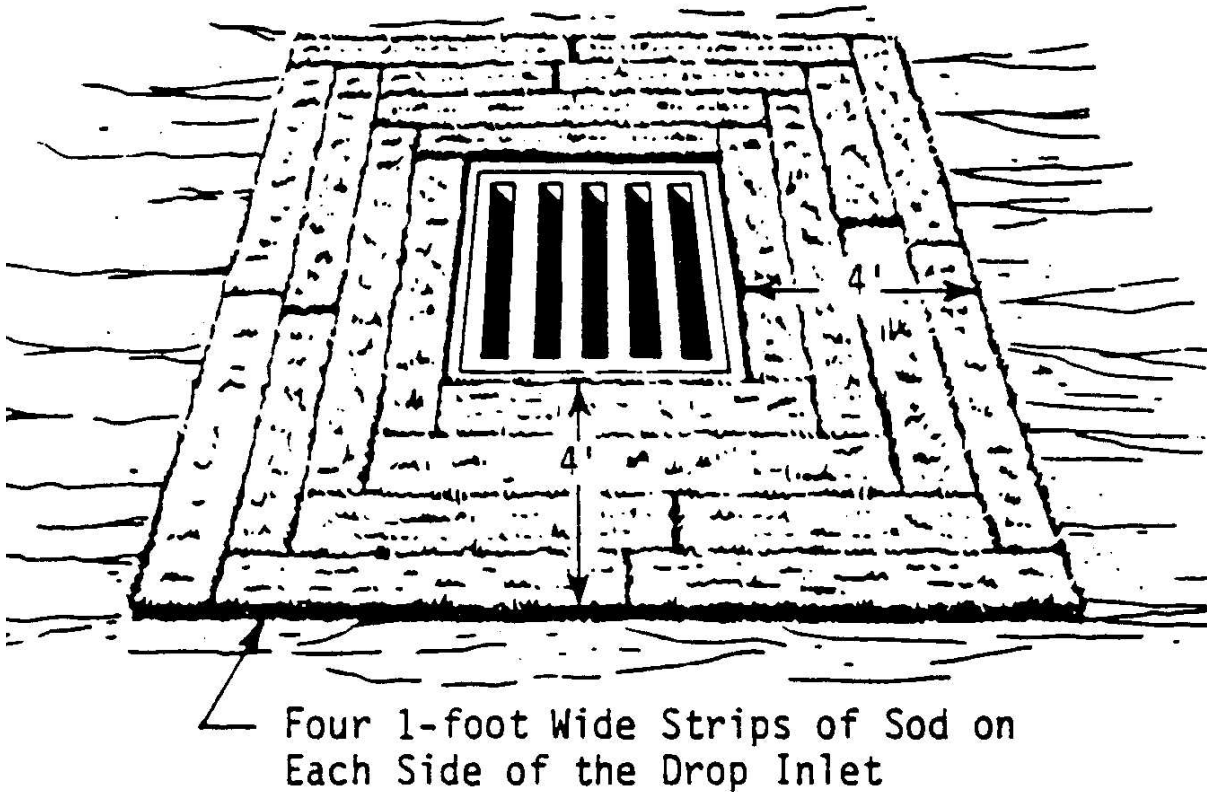
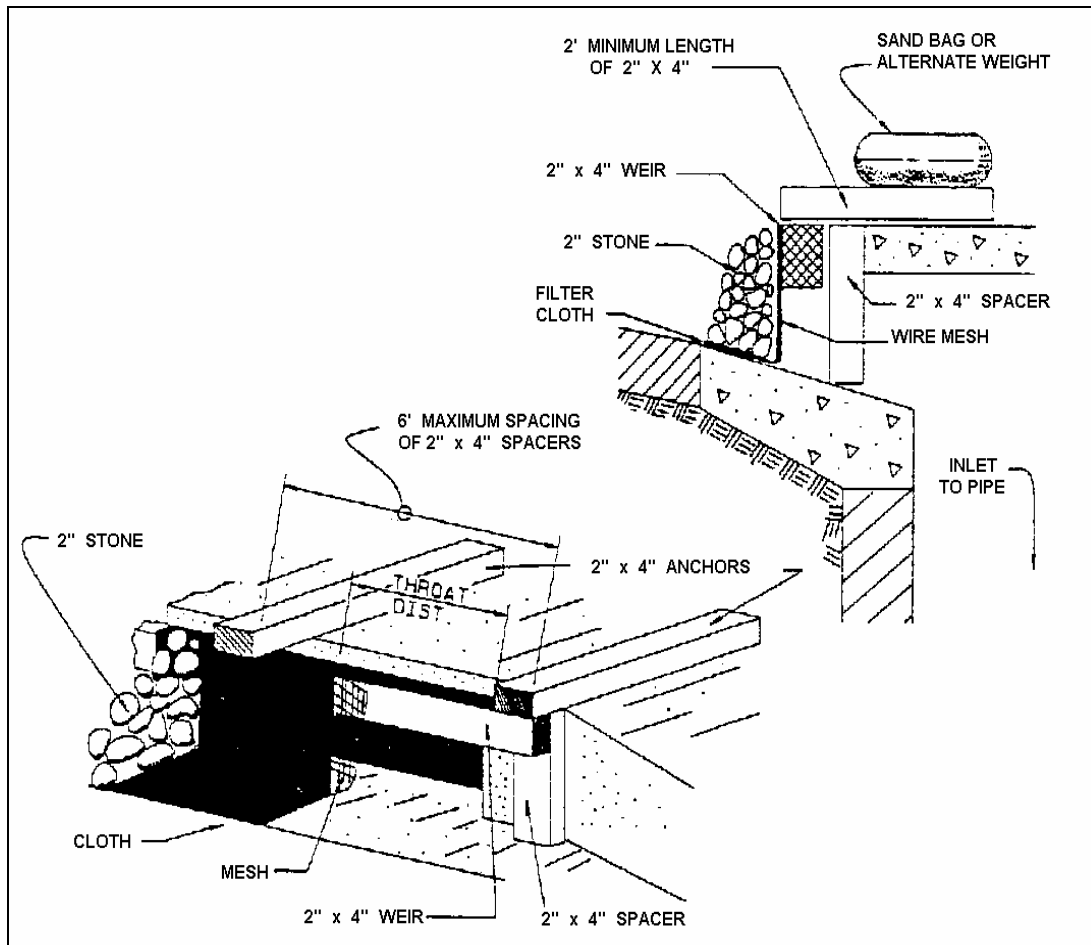

Figure 3.18. Sod drop inlet protection (Source: Department of Civil, Construction, and Environmental Engineering, Iowa State University)

#### Construction specifications

1. Bring the area to be sodded to final grade elevation with topsoil. Add fertilizer and lime, and install sod in accordance with the practice on sodding.
2. Lay all sod strips perpendicular to the direction of flow.
3. Maintain a minimum width of 4 ft in all flow directions.
4. Sod strips shall be staggered so adjacent strip ends are not aligned.
5. Maximum Drainage Area = .25 acres



**Figure 3.19. Curb gutter inlet protection (Source: Department of Civil, Construction, and Environmental Engineering, Iowa State University)**

**Construction specifications**

1. Wooden frame shall be construction of 2 by 4 in. construction-grade lumber.
2. Wire mesh across throat shall be a continuous piece with a 30 in. minimum width and a length 4 ft longer than the throat. The mesh shall be shaped and securely nailed to a 2 by 4 in. weir.
3. The weir shall be securely nailed to 2 by 4 in. spacer, 9 in. long, and spaced no more than 6 ft apart.
4. The assembly shall be placed against the inlet and secured by 2 by 4 in. anchors, 2 ft long and extended across the top of the inlet and held in place by sandbags or alternate weights.
5. Maximum drainage area = 1 acre.

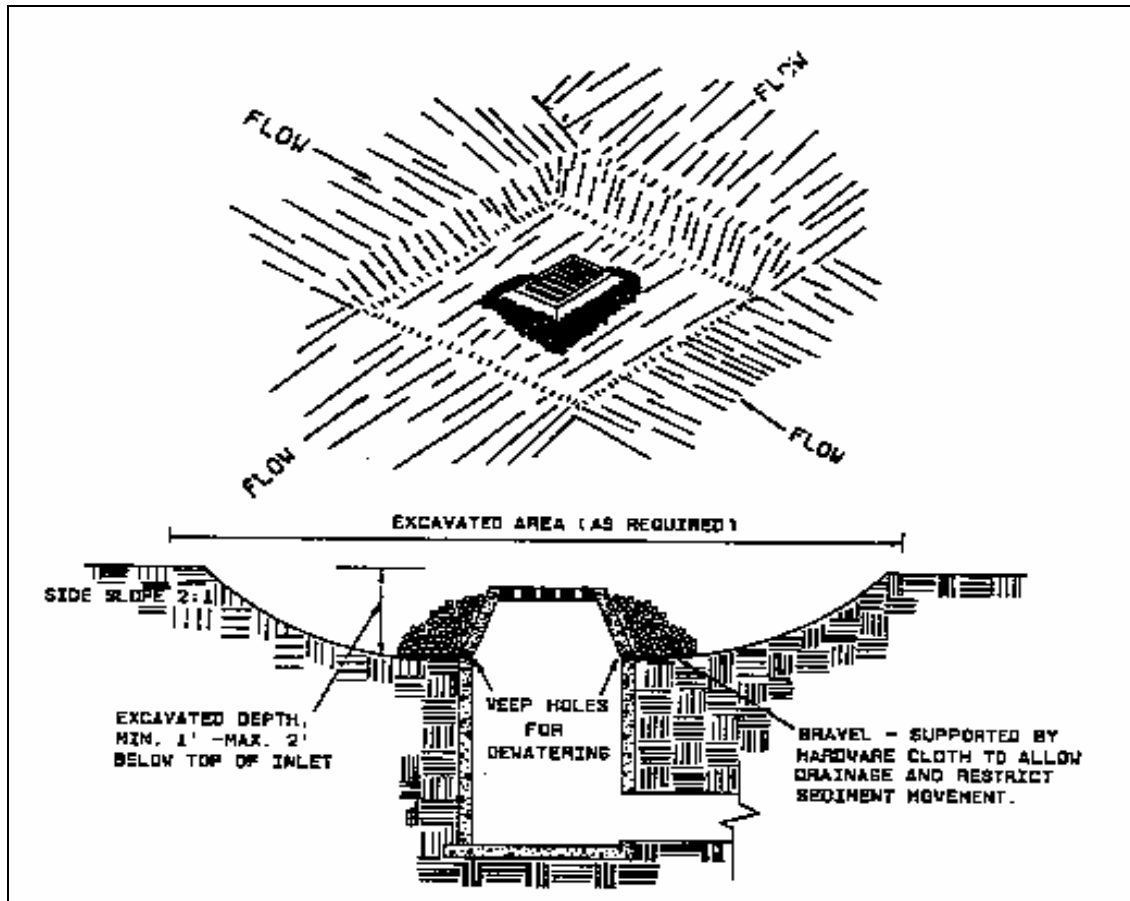

**Figure 3.20. Excavated drop inlet protection (Source: Department of Civil, Construction, and Environmental Engineering, Iowa State University)**

#### Construction specifications

1. Clear the area of all debris that will hinder excavation.
2. Grade approach to the inlet uniformly around the basin.
3. Weep holes shall be protected by gravel.
4. Upon stabilization of the contributing drainage area, seal weep holes and fill the basin with stable soil to final grade. Compact it properly and stabilize with permanent seeding.
5. Maximum drainage area = 1 acre.

## 3.10 JETTIES



**Figure 3.21. Jetty (Source: Department of Civil, Construction, and Environmental Engineering, Iowa State University)**

### Overview

**Description:** Used to deflect water currents away from selected sections of a streambank.

**Problem identification:** A streambank under stress from water currents needs to be protected from erosion.

**Design purpose:** To redirect stream currents away from the streambank to reduce erosion.

**Associated practices:** Used where one waterway meets another on new construction or where there is a shift in alignment.

**Installation:** Logs or planks are installed to move the current, and riprap underlaid with filter fabric, boulders, or gabions is installed. The material must be sized for the conditions at the distressed area.

**Maintenance/inspection:** Protected or repaired areas should be inspected after precipitation events for any damage or displacement of material. Any problem area must be repaired or reinforced as soon as possible.

**Design life:** Permanent.

**Estimated cost:** Riprap costs \$32.20 per ton (aggregate material cost only).



**Figure 3.22. Jetties (Source: Department of Civil, Construction, and Environmental Engineering, Iowa State University)**

## 3.11 LEVEL SPREADER



Figure 3.23. Level spreader installation (Source: William B. Umstead State Park)

### Overview

**Description:** A storm flow outlet device constructed at zero grade across a slope to allow concentrated runoff to empty at a non-erosive velocity onto an area stabilized by existing vegetation.

**Problem identification:** Runoff at the outlet of diversion ditches must be controlled to prevent sheet erosion as the runoff spreads out and reduces in velocity.

**Design purpose:** To change storm runoff at the outlet to non-erosive sheet flow.

**Associated practices:** Used at the terminal end of waterways or diversion structures.

**Installation:** A transition section 10–20 ft long should be constructed from the width of the channel to the width of the spreader to ensure uniform flow. The transition section will blend the channel grade to zero grade at the beginning of the spreader. The spreader will have the level lip constructed on a 0% grade. The level spreader must be constructed on undisturbed soil. The lip of the spreader should be protected with an erosion-resistant material, such as excelsior matting, to allow vegetation to become established.

**Maintenance/inspection:** The device should be inspected periodically to ensure the intended purpose is accomplished. Maintain as necessary so that the level spreader functions.

**Design life:** One year.



## 3.12 ROCK OUTLET PROTECTION



Figure 3.24. Rock outlet protection (Source: Iowa DOT)

### Overview

**Description:** A structurally lined apron or other energy dissipating device placed at the outlet of a drainage pipe.

**Problem identification:** Scour at pipe outlets needs to be prevented and the potential for downstream erosion needs to be reduced by slowing the velocity of concentrated storm water flow.

**Design purpose:** To reduce the velocity of the flow from the outlet of a pipe before the water enters the receiving channel to reduce erosion and prevent scour.

**Associated practices:** This condition applies to all pipes and paved channel sections where the outlet's velocity of flow at design capacity exceeds the velocity of the receiving channel. This method can also be used as way to reduce water energy and velocity in the case of level spreaders.

**Installation:** Structurally lined aprons at the outlets of pipes and paved channel sections should be designed according to the guidelines found in the SUDAS Design Manual, Chapter 7, Section 7E-18, Rock Outlet Protection.

**Maintenance/inspection:** Periodic inspection is required. Repair as necessary.

**Design life:** Temporary or permanent.

**Estimated cost:** Riprap costs \$32.20 per ton.

### 3.13 RETAINING WALL



**Figure 3.25. Retaining Wall (Source: Department of Civil, Construction, and Environmental Engineering, Iowa State University)**

#### Overview

**Description:** A wall constructed to assist in the stabilization of a cut or fill slope, where maximum permissible slopes are not attainable without the use of the wall.

**Problem identification:** Additional slope reinforcement is needed because of unstable material or space limitations.

**Design Purpose:** To construct an attractive slope that will provide a safe area below.

**Associated practices:** Used in areas of unstable soils where earth slides may occur, where the slopes are steeper than the angle of repose, or where the horizontal distance is limited.

**Installation:** A number of materials are available for stabilizing steep slopes. For the most part, they are permanent in nature. The following materials can make satisfactory walls: concrete masonry, concrete cribbing, gabions, precast stone, reinforced earth, steel piling, stone drywall, rock riprap, and treated wood timbers.

Many factors must be taken into account in the design of a retaining wall. Some of those factors include thickness, stress, foundation design, bearing value of the soil, height of the wall, and drainage. Since each situation requires a specific design, a qualified designer is recommended.

**Maintenance/inspection:** Inspection is recommended on a monthly basis for the first year and then immediately after a severe precipitation event. Correct problems as soon as possible.

**Design life:** Permanent.

**Estimated cost:** Unit costs vary with the surface materials selected.

## 3.14 STABILIZED CONSTRUCTION ENTRANCE



**Figure 3.26. Temporary stabilized construction entrance to construction site (Source: Department of Civil, Construction, and Environmental Engineering, Iowa State University)**

### Overview

**Description:** A crushed rock- or gravel-stabilized pad located at points of vehicular ingress and egress on a construction site.

**Problem identification:** Sediment in the form of mud can be transported by vehicles to adjacent public or private property. Steps need to be taken to minimize that transport.

**Design purpose:** To reduce the amount of mud on vehicle tires before vehicles enter a public road.

**Associated practices:** Used where traffic leaves a construction site and moves directly onto a public road or other paved or granular surface.

**Installation:** The entrance should be located to provide for maximum use by all construction vehicles. The aggregate layer must be at least 6 in. thick. The pad must be the full width of the vehicle entrance and exit area. The length of the entrance must be at least 50 ft. If conditions on the site are such that the majority of the mud is not removed when vehicles travel over the aggregate, then vehicle tires should be washed before entering a public road. Wash water should be carried away from the entrance to a settling basin to remove the sediment.

**Maintenance/inspection:** The condition of the aggregate needs to be monitored daily. The entrance should be maintained in a condition that will prevent tracking or flow of mud onto a public road. Any accumulation of mud must be removed and more aggregate added as needed. This may require top dressing with two-inch stone as conditions demand.

**Design life:** Varies, based on site conditions and traffic volume.

**Estimated cost:** Costs vary with aggregate size, source, and transportation charges.

## 3.15 RIPRAP



**Figure 3.27. Riprap (Source: Department of Civil, Construction, and Environmental Engineering, Iowa State University)**

### Overview

**Description:** A permanent, erosion-resistant ground cover of large, loose, angular stone.

**Problem identification:** The surface of the soil needs to be protected from the erosive forces of concentrated stormwater runoff.

**Design purpose:** To provide a protective, non-erosive cover and to slow the velocity of concentrated runoff.

**Associated practices:** This control measure is used at the outlet of drain pipes, in areas of high velocities and concentrated flow, or where waterway bottoms are eroding. Riprap may also be used as revetment.

**Installation:** Stone weight is approximately 165 lbs/cu ft. Riprap should be well-bedded in a stable channel bottom for a depth of 1.5 to 3.0 ft, depending on the size of the stone. The channel side slopes shall be prepared to the required lines and grades. Riprap should be placed over filter fabric. The stone shall be hand-placed around structures. The riprap should extend up the slope to the point at which vegetation will provide adequate protection. The stone should be reasonably well-graded.

**Maintenance/inspection:** Inspect after severe precipitation events and make repairs immediately. In some cases, riprap may be undersized.

**Design life:** Permanent.

**Estimated cost:** Riprap costs \$32.20 per ton (2004).

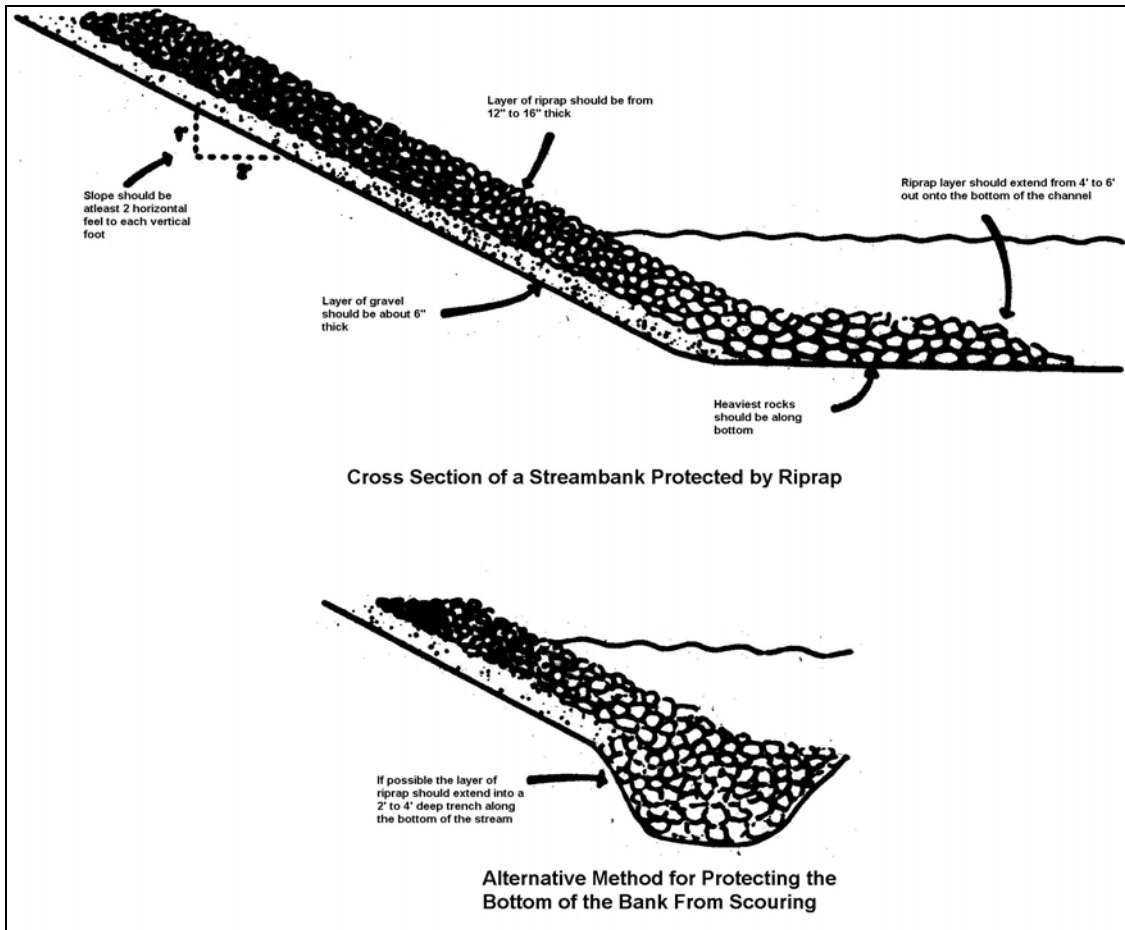

Figure 3.28. Use of riprap to protect streambanks and bottoms (Source: Department of Civil, Construction, and Environmental Engineering, Iowa State University)

Table 3.2. Size of riprap stones

Weight (lbs)	Mean spherical diameter (ft)	Rectangular shape	
		Length (ft)	Width/height (ft)
50	0.8	1.4	0.5
100	1.1	1.75	0.6
150	1.3	2.0	0.67
300	1.6	2.6	0.9
500	1.9	3.0	1.0
1000	2.2	3.7	1.25
1500	2.6	4.7	1.5
2000	2.75	5.4	1.8
4000	3.6	6.0	2.0
6000	4.0	6.9	2.3
8000	4.5	7.6	2.5
20000	6.1	10.0	3.3

## 3.16 SEDIMENT BARRIER



**Figure 3.29. Silt fence sediment barrier (Source: Department of Civil, Construction, and Environmental Engineering, Iowa State University)**

### Overview

**Description:** Sediment barriers are temporary structures that filter runoff so the water continues while the sediment stays on the site.

**Problem identification:** Sediment carried by sheet flow should be prevented from leaving the construction site.

**Design purpose:** To retain the sediment on construction sites of one-half acre or less.

**Associated practices:** As soon as the vegetation is removed by construction activity, sediment barriers should be used extensively in drainage ditches and waterways.

**Installation:** All barriers should be placed on the contour. On-slope barriers should be placed no more than 50 ft apart. The most commonly used materials for sediment barriers are sandbags and silt fences.

1. Sandbags: Sandbags should be installed so that the flow under or between bags is minimal. If the height exceeds two bags, anchoring with stakes may be required.
2. Silt fence: A silt fence is designed to allow water to pass through while retaining the sediment on the site. The silt fence should be installed in accordance with the details set forth in this manual.

**Maintenance/inspection:** Inspect periodically or after each precipitation event. The sediment barrier must be maintained until the project is vegetated or accepted. If the sediment barrier deteriorates to the point at which it loses its effectiveness, it should be replaced.

**Design life:** Six to nine months.

**Estimated cost:** Silt fence costs \$2.80 per linear ft (2004).

### 3.17 SEDIMENT BASIN

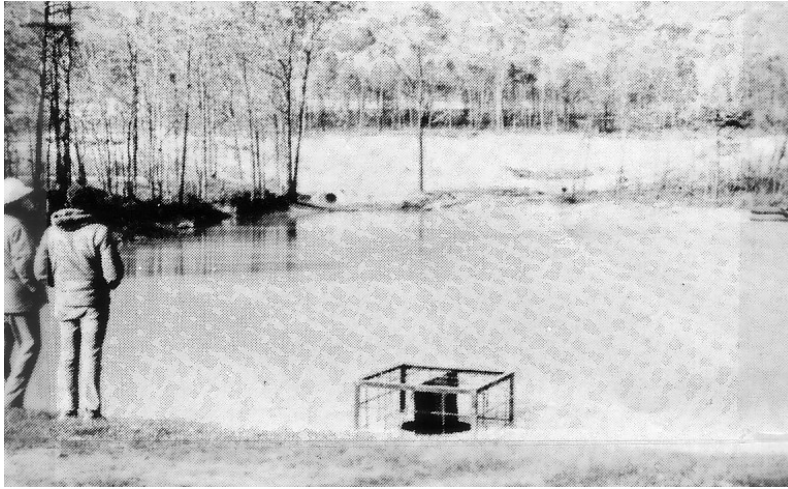

**Figure 3.30. Sediment basin (Source: Department of Civil, Construction, and Environmental Engineering, Iowa State University)**

#### Overview

**Description:** A basin created by building a dam across a waterway, excavating a basin, or a combination of both. A sediment basin usually consists of a dam, a pipe outlet, and an emergency spillway. Sediment basins are much larger than sediment traps, serving drainage areas up to 100 acres.

**Problem identification:** All surface water runoff from a construction site should have all sediment removed before the water exits the construction site.

**Design purpose:** To collect runoff in a manner that will allow the sediment to drop to the bottom of the containment device and clear water to exit the site.

**Associated practices:** A sediment basin is appropriate in critical areas where physical site conditions, construction schedules, or other restrictions prevent the installation of other erosion control measures that would adequately control runoff, erosion, and sedimentation.

**Installation:** The sediment basin should be located to allow maximum storage for the site, ease of cleanout, and disposal of the trapped sediment. The basin should be located where it will minimize interference with construction activities. When possible, the basin should be located so that storm drains can be diverted into the basin. Basins should be built in existing drainage ditches and constructed before grading begins.

The size of the sediment basin, as measured from the bottom of the basin to the principal spillway, should provide at least 3,600 cu ft of storage per acre of drainage. This provides storage equal to 1 in. of runoff per acre. Likewise, 1,800 cu ft amounts to 1/2 in. of sediment per acre. The basin should be cleaned when the volume of sediment reaches 900 cu ft per acre. At this time, the cleanout shall be performed to restore the original design capacity of the basin. At no time should the sediment level be permitted to build higher than 1 ft below the principal outlet.

The length of a sediment basin should be more than twice the width of the basin. The length is considered to be the distance between the inlet and the outlet.

The principal outlet should consist of a vertical pipe or box-type riser connected to a pipe that extends through the embankment and outlets beyond the downstream toe of the fill. The minimum capacity of the outlet pipe should be 0.2 cfs per acre of drainage area.

It is recommended that a qualified professional designs the sediment basin.

The next installation regulations should be followed:

1. Drainage area to the basin is 10 acres or less.
2. An emergency outlet is required.
3. One anti-seep collar shall be used and placed 25 ft from the riser.
4. Watertight bands should be used.
5. All pipe material should be good quality with no holes.
6. Volume of storage computed as 3,600 cu ft. per acre of drainage area.

**Maintenance/inspection:** Inspect daily for damage caused by rodents or soil erosion. The basin should be maintained until the disturbed areas are protected against erosion by permanent stabilization. The sediment shall be removed when it reaches the cleanout level. The sediment shall be spread on the construction site in such a location that it does not reenter the sediment basin.

When the structure has served its intended purpose and the contributing drainage has been stabilized, the embankment and sediment deposits should be disposed of in an approved method, and the area should be seeded.

**Design Life:** Eighteen months; can be converted to permanent.

**Estimated Cost:** Costs vary with size of the basin and size of dam construction.



## 3.18 STREAMBANK PROTECTION



Figure 3.31. Streambank protection (Source: International Erosion Control Association)

### Overview

**Description:** A permanent structural control measure to stabilize an eroding streambank.

**Problem identification:** Special erosion control measures are needed where stream velocities exceed six fps.

**Design purpose:** To stabilize eroding streambanks permanently.

**Associated practices:** Streambank protection is often necessary when flow velocities are more than six fps or where vegetative protection is not appropriate. Excessive runoff or construction activities may cause an erosion problem to develop.

**Installation:** See the Iowa DNR Streambank Erosion Control Manual for details on installing bioengineering or structural methods of control.

**Maintenance/inspection:** Inspect the stabilized streambank sections after every high-water event. Make any needed repairs immediately to prevent any further damage to the streambank.

**Design life:** Permanent.

**Estimated cost:** Costs will vary with method used (from bioengineering to structural sections).

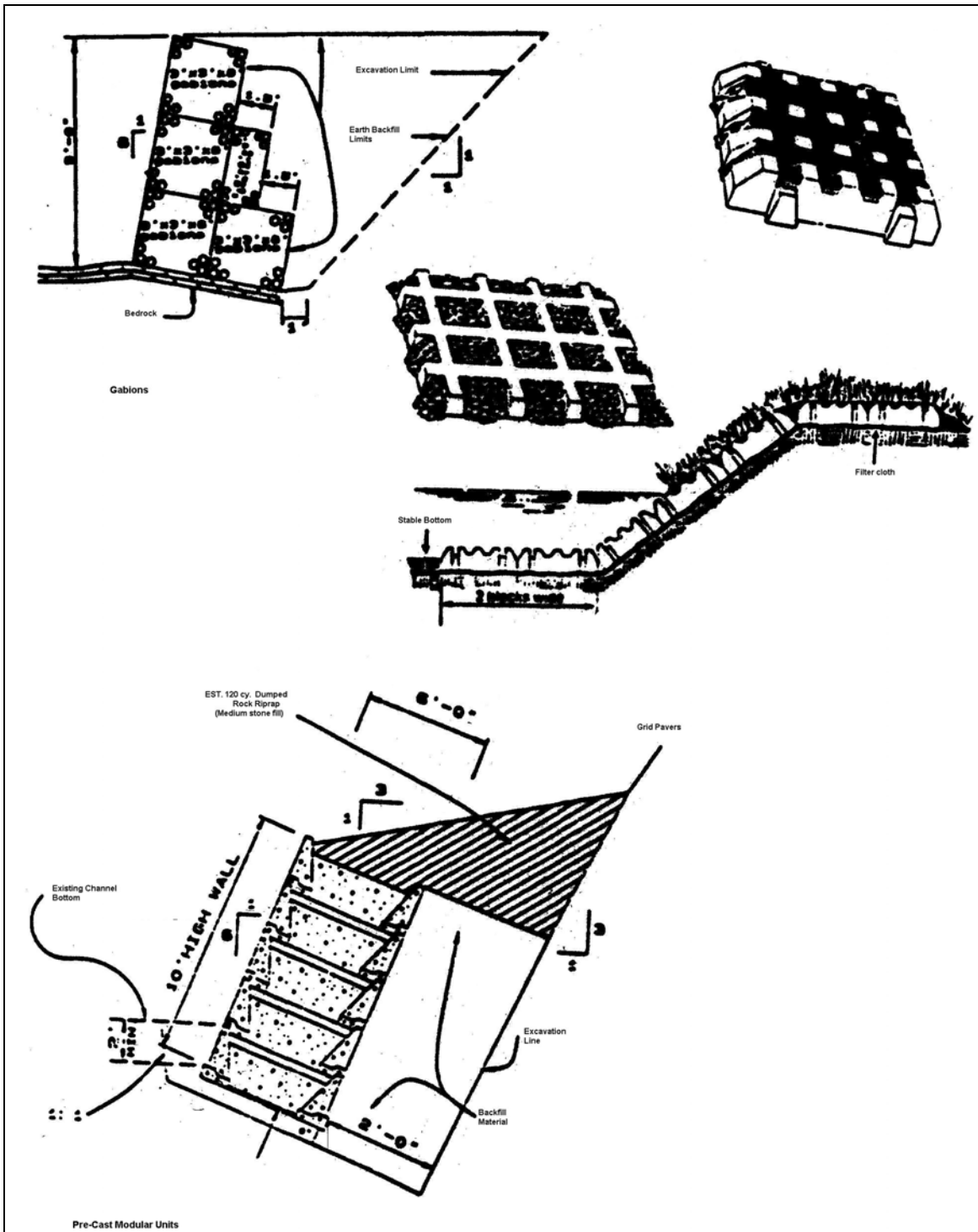

Figure 3.32. Streambank protection measures (Source: Department of Civil, Construction, and Environmental Engineering, Iowa State University)

## 3.19 STREAM CHANNEL ENHANCEMENT



Figure 3.33. Stream channel enhancement (Source: Natural Resources Conservation Service)

### Overview

**Description:** The use of vegetation to improve the visual qualities of stream channels and banks.

**Problem identification:** Creek channels and banks may have been adversely affected by excess runoff or excavation from construction activities.

**Design purpose:** To protect the streambank from erosion by use of bioengineering techniques and to improve bank aesthetics.

**Associated practices:** Increased storm frequency and excessive runoff may destroy the natural beauty of a stream. With streambank plantings, the area can be enhanced. The protection provided by natural vegetation is also more reliable and effective when the cover consists of natural plant communities adapted to their site.

**Installation:** Four vegetative zones exist along most waterways. They include the aquatic, reed bank, shrub, and tree zones. The aquatic plant zone is difficult to establish artificially. The reed bank plants include reed canary grass, bulrush, and cattail. These deep- and strong-rooted plants tend to bind the soil together. Shrubs provide good bank protection. Willow shrubs are easy to plant and are fast growers. They can be started with cuttings just pushed into the soil, where they will root and grow.

If the area receives a good deal of sun, permanent seeding can be done. A seed mixture containing a high percentage of Kentucky 31 fescue is a desirable grass.

***Maintenance/ inspection:*** Inspect after each high-water event. Streambanks are vulnerable to damage, and repairs are needed periodically. Repair gaps in vegetative cover at once with new plants or cuttings. Trees that become established on the bank should be removed.

***Design life:*** Twneety-five years or more.

***Estimated cost:*** Costs vary with channel length and initial condition of the channel.

## 3.20 SUBSURFACE DRAINAGE

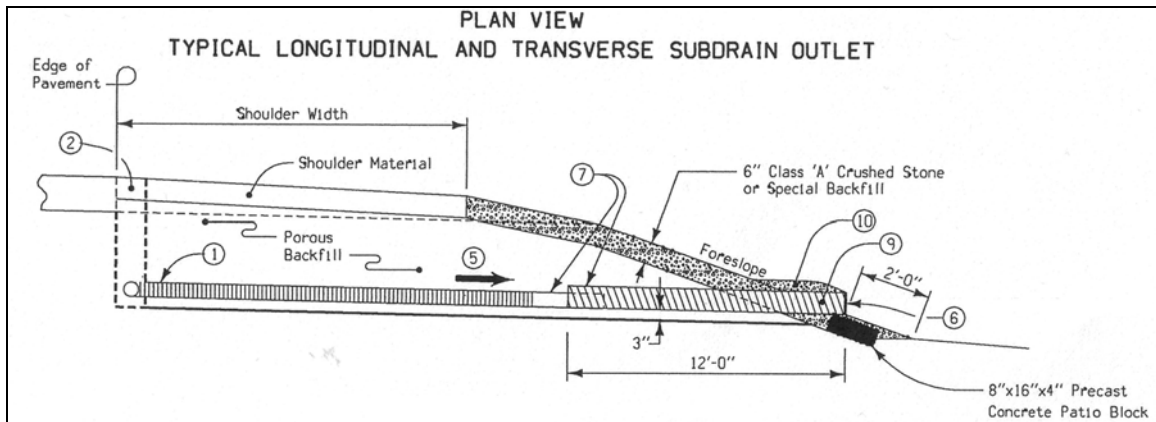

Figure 3.34. Subsurface drainage (Source: Iowa DOT)

### Overview

**Description:** A perforated conduit, such as a pipe, tubing, or tiles, installed beneath the ground to intercept and convey ground water.

**Problem identification:** Soils may become excessively wet and subject to sloughing.

**Design purpose:** To remove excess water from the soil.

**Associated practices:** To remove excessive water that collects during the excavation phase of construction or to improve plant growth by lowering the water table.

**Installation:** The three types of subsurface drainage systems are sump pit drains, relief drains, and interceptor drains.

1. A sump pit drain consists of one or more pits to intercept ground water. The pit is dug so that the bottom is 12 in. lower than the depth that needs to be dewatered. A perforated vertical standpipe is placed in the center of the pit, which is backfilled with 2 in. rock or gravel. The water is pumped from the center of the pipe to a suitable discharge area.
2. Relief drains are used to lower the water table or to remove surface water. They are installed along a slope and drain in the direction of the slope. They can be installed in a gridiron pattern, a herringbone pattern, or a random pattern. Relief drains should be located through the center of the wet areas. This system is similar to agricultural systems. Gravity outlets must be provided for relief drains.
3. Interceptor drains remove water as it seeps down a slope to prevent the soil from becoming saturated and subject to slippage. Interceptor drains should be located on the uphill side of the wet areas. The drains should be installed across the slope and drain to the side of the slope. Gravity outlets must be provided for interceptor drains.

**Maintenance/inspection:** Inspect outlets monthly to ensure they are not plugged, and unplug if necessary. Repair any erosion that may be present.

**Design life:** Sump pit: For the life of the project construction.  
 Relief drains: Permanent.  
 Interceptor drains: Permanent.

**Estimated Cost:** Unit cost varies with drainage layout, depth of placement, material selection, installation method, and outlet control selection.

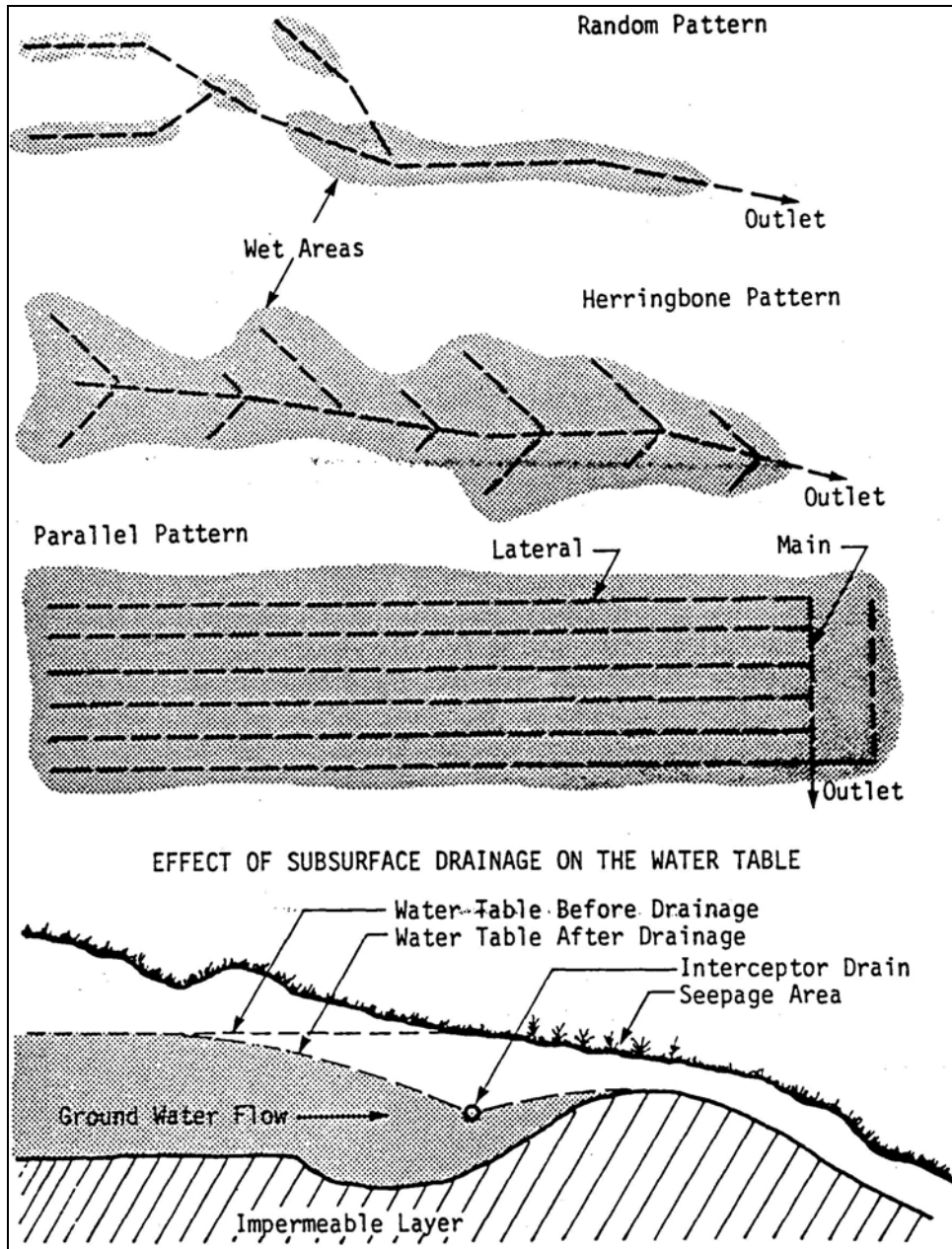

Figure 3.35. Subsurface drainage patterns (Source: Department of Civil, Construction, and Environmental Engineering, Iowa State University)

## 3.21 DIVERSION STRUCTURE

### Overview

**Description:** An excavated swale, berm, or combination of the two, constructed in such a manner as to direct water to a desired location or temporarily divert water around an area that is under construction or is being stabilized. Specific applications include perimeter control, diversion away from disturbed slopes, and diversion of sediment-laden water to treatment facilities. This is accomplished by constructing a swale and/or berm at the top of the slope, and conveying it to a letdown structure or stable outlet. On long slopes, diversion structures can be placed at regular intervals to trap and divert sheet flow before it concentrates and causes rill and gully erosion.

**Problem identification:** During construction, it is often necessary to divert upstream waters around the construction site, thereby reducing the erosion potential. Clean water passing through the site needs to be separated from the sediment-laden water, thus reducing the required size of the sediment removal structure at the downstream end of the construction site.

Diversion structures are also needed to keep upstream water off disturbed slopes or to carry water down the slope without attracting sediment.

**Design purpose:** To intercept surface and shallow subsurface flows and divert this water away from disturbed areas, active gullies, and critically eroding areas. Diversion structures can also be constructed along slopes to reduce the slope length, intercepting and carrying runoff to a stable outlet point or letdown structure.

The advantages of diversion structures include the following:

- Reduces the volume of flow across disturbed areas, thereby reducing the potential for erosion
- Breaks up the concentration of water on long slopes
- Allows sediment basins and traps to function efficiently by maintaining a separation between clean water and sediment-laden water
- Easily constructed with equipment found on most construction sites

The limitations of diversion structures include the following:

- High flow velocities can cause erosion in the diversion structure
- Diversion structures must be stabilized immediately after installation

**Associated practices:** Used with slope drains.

**Installation:** Diversion structures should be used around the perimeter of sites to prevent run-on of offsite flows over disturbed ground. If diversion structures are constructed during times when vegetation cannot be established to stabilize the surface, alternative stabilization methods such as sodding or matting may be required.

Each structure should be designed to carry peak flows from the 2-year, 24-hour storm. The maximum drainage area conveyed through a diversion structure should be 5 acres. The depth of the diversion should be based on the design capacity plus an additional 4 in. of freeboard. The minimum depth provided should be 18 inches. This may be provided solely by a berm or swale

or may be developed with a combination of berm and swale. The shape of the diversion may be parabolic, trapezoidal, or V-shaped, with side slopes of 2:1 or flatter.

The allowable velocity within the diversion structure is based on the soil characteristics of the site. Silty and sandy soils are more prone to erosion than clay soils. However, with the proper design and stabilization methods, diversion structures may be used in all appropriate locations.

The minimum slope of the diversion structure should be sufficient to carry the design flow. The maximum slope of the diversion is limited by the permissible velocities of flows within the structure, as shown in Table 3.3. Since any stabilizing vegetation will likely be destroyed upon construction of the diversion structure, the bare surface situation should be considered for most applications.

**Table 3.3. Diversion structure slopes by soil type (Source: Smoot 1999)**

Soil type	Permissible velocity, fps for varying channel vegetation			
	Bare	Poor	Fair	Good
Sand, silt, sandy loam, and silty loam	1.5	1.5	2.0	3.0
Sandy clay and sandy clay loam	2.0	2.5	3.0	4.0
Clay	2.5	3.0	4.0	5.0

After construction of the diversion structure, it is important to stabilize the surface immediately with seed and mulch, sod, or other materials.

**Maintenance/inspection:** Inspect every seven days and after any one-half in. or greater rainfall. Any damage to the vegetated lining should be repaired. All debris should be removed and properly disposed of to provide adequate flow conveyance.

**Design life:** One year.

**Estimated cost:** Cost varies with the length and sizing of the diversion structures.



# CHAPTER 4. SPECIAL CONDITION EROSION CONTROL MEASURES

## 4.1 INFILTRATION BASIN AND TRENCH

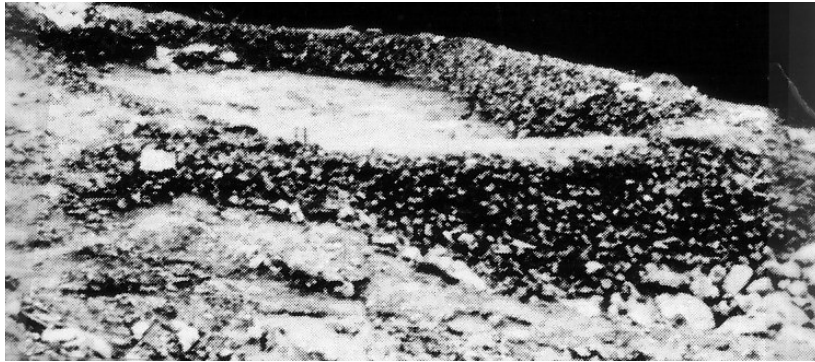

**Figure 4.1. Infiltration basin and trench (Source: Department of Civil, Construction, and Environmental Engineering, Iowa State University)**

### Overview

**Description:** A depressed area formed by the removal of overburden to expose a porous or sandy soil that allows the flow of runoff water to be absorbed.

**Problem identification:** Storm water runoff needs to be disposed of. An infiltration basin or trench is used when the quantity of runoff water is small, the drainage area is less than one acre, and there is an area within the construction site in which the subsoil is sand.

**Design purpose:** A practical way of disposing of small quantities of storm runoff when the runoff is free of pollutants.

**Associated practices:** The infiltration basin or trench serves as the outlet of a waterway and is used for disposal of runoff water.

**Installation:** The overburden is removed to form a basin or a trench and to expose the porous soil. Care must be taken when the overburden is removed so that it is not disposed of in an area on the site where it will be eroded into the infiltration structure. The basin or trench should provide an estimated 35 cu yd of storage space per acre.

**Maintenance/inspection:** Inspect after each precipitation event. Remove weeds and debris, keep the basin or trench free of vegetative growth, and keep sediment out of the area.

**Design life:** Two to five years.

**Estimated cost:** Basin or trench costs \$210.00 for each option.

## 4.2 RETENTION POND



**Figure 4.2. Retention pond (Source: Department of Civil, Construction, and Environmental Engineering, Iowa State University)**

### Overview

**Description:** A permanent pool of water that has the capacity to store storm water temporarily until it is released from the structure.

**Problem identification:** A retention pond interrupts the transport phase of sediment and pollutants, store storm water, and improve the quality of water when released.

**Design purpose:** To reduce sediment, improve water quality, and store storm water runoff. Retention ponds are one of the better management practices for the handling of storm water runoff.

**Associated practices:** Used with sediment basins and waterways. With additional planning and design, detention ponds can be used for water quality improvement. Pollutants will be diluted when held or delayed in a retention pond. Retention ponds are also used for silt control and improvement of the runoff water quality.

**Installation:** The site for a retention pond should have suitable soils to prevent excessive seepage. The drainage area for a detention pond must be large enough to provide a permanent pool. Generally, four acres are required for each acre-foot of storage in the pond. Smaller drainage areas function best as a means of sediment control while maintaining a permanent pool. A qualified designer is recommended.

**Maintenance/inspection:** Retention ponds need to be monitored on a regular basis. Look for excessive seepage, the condition of the fill, and the amount of sediment present. Necessary

repairs to the structure should be done as soon as possible. Sediment should be removed when it is 1 to 1.5 ft deep. It should be placed in an area where it will not reenter the system. Grass should be mowed, weeds controlled, eroded areas repaired, and debris removed. Prompt repair action can reduce maintenance costs.

*Design life:* Ten years, based on sediment control.

*Estimated cost:* Variable, depending on the pond's size and effectiveness.

## 4.3 SERRATED CUT



**Figure 4.3. Serrated cut (Source: Department of Civil, Construction, and Environmental Engineering, Iowa State University)**

### Overview

**Description:** Serrated cut or stair-step grading used in soils containing large amounts of soft rock where it may be impractical to smooth grade.

**Problem identification:** Soft rock in cut areas prevents the area from being sloped to allow vegetation to be established after grading is complete.

**Design purpose:** Each step catches material from above and provides a flat area where vegetation can become established.

**Associated practices:** Used in soft rock when it is difficult to obtain a smooth slope.

**Installation:** Each step shall be constructed on the contour and will have steps at nominal 2 ft intervals with nominal 3 ft horizontal shelves. Steps may vary, depending on the slope ratio. The nominal slope line is 1.5:1. The steps will weather and act to hold seed and fertilizer and will produce quicker and longer-lived vegetative cover, as well as better slope stabilization. Surface water should be diverted from the face of all cuts.

**Maintenance/inspection:** Check on a monthly basis for any loose rock and any runoff flows that are detrimental to the finished product. Remove and dispose of loose rock and make any drainage corrections.

**Design life:** Permanent.

**Estimated Cost:** Costs are based on the material type to be excavated and the equipment selected for the construction.

## 4.4 TEMPORARY STREAM CROSSING



Figure 4.4. Temporary stream crossing (Source: F. X. Browne, Inc.)

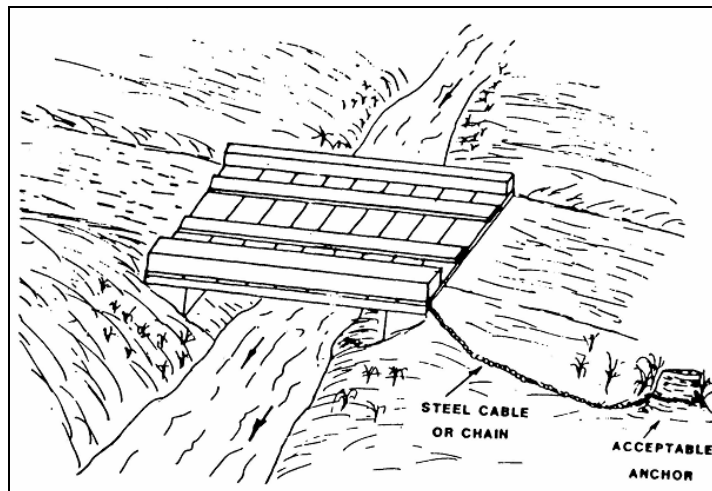

Figure 4.5. Temporary bridge for construction equipment access (Source: Department of Civil, Construction, and Environmental Engineering, Iowa State University)

## Overview

**Description:** A temporary structure, such as a bridge or pipe, installed across a flowing stream or waterway for use by construction equipment.

**Problem identification:** A crossing method is needed to prevent streambank damage and to control sediment where existing waterways must be crossed during construction.

**Design purpose:** To provide a structure large enough to carry a full bank flow without appreciably altering the stream flow characteristics.

**Associated practices:** Required when construction is necessary across a small stream with flowing water.

**Installation:** A bridge is considered more practical than pipes. If pipes are used, they should adequately carry the flow of water. The drainage area should be less than one sq mi. For larger drainage areas, a professional engineer should prepare the design.

Only rock can be used for backfill within the channel limits of the stream. The minimum width of roadway surface shall be 12 ft. The structure shall be removed within 14 days after the structure is no longer needed.

A permit may be required from the Department of Natural Resources to cover installation and removal of the crossing.

**Maintenance/inspection:** Inspect daily to prevent damage to the stream. After high-water events, the crossing should be carefully reviewed for any damage. All damage to the crossing shall be repaired at once.

**Design life:** Temporary; to be removed 14 days after it is no longer needed.

**Estimated cost:** Costs vary with materials used in the crossing construction.

## 4.5 WETLANDS



**Figure 4.6. Urban wetlands (Source: Department of Civil, Construction, and Environmental Engineering, Iowa State University)**

### Overview

**Description:** An important control measure for the removal of sediment, nutrients, and urban pollutants by passing runoff water through a constructed wetland area. Nutrients can be taken up and stored by wetland vegetation on a short-term basis. For a longer period of time, vegetation may remove nutrients and then lose them in the sediment below. Dense wetland vegetation also slows the flow of sediment-laden water. The slower the water, the greater the amount of sediment that sinks to the bottom along with the nutrients that become buried.

**Problem identification:** Some erosion planning can be used to provide long-term retention of runoff during and after construction for sediment collection and water quality improvement as part of a large-area water runoff control plan.

**Design purpose:** To effectively remove sediment, nutrients, and urban pollutants and release an improved quality of water from the site.

**Associated practices:** Built in conjunction with new permanent waterways and ditches for disposal of runoff. Note that natural wetlands should not be altered in any way. Any alterations to existing wetlands for use in construction site erosion control will require the review and approval of the Iowa Department of Natural Resources.

**Installation:** A successful wetland needs to be about 3% of the size of the drainage area. About 25% of the wetland needs to be 2 to 3 ft deep and the remainder needs to be 1 ft deep. All areas 2 ft deep or deeper will remain open water, while the remaining 1 ft deep areas will support vegetation. A good seal at the bottom of the wetland area is required.

The major concern with wetland treatment is damage that may be done environmentally to a natural wetland. Concern is also present for the large land area required for constructed wetlands.

Note that a permit is required from the Department of Natural Resources.

***Maintenance/inspection:*** Check for excess seepage and water level and repair any damage.

***Design life:*** Twenty-five years or longer, depending on maintenance activities.



---

# REFERENCES

---

1. Association of Illinois Soil and Water Conservation Districts, "Procedures and Standards for Urban Soil Erosion and Sedimentation Control in Illinois," revised July 1988, also current revisions.
2. Better Roads, "Permeable Ditch Berm," pp 71, June 2003.
3. Center for Watershed Protection Stormwater Management Projects, [http://www.cwp.org/stormwater\\_mgt.htm](http://www.cwp.org/stormwater_mgt.htm), 2000-2004.
4. Clyde, C; Israelson; Packer; Farmer; Fletcher; Israelson; Haws; Rao and Hansen, Utah Water Research Laboratory, College of Engineering, Utah State University, "Manual of Erosion Control Principles and Practices," June 1978.
5. Commonwealth of Virginia, certification Program for "Erosion and Sediment Control, Stormwater Management Program, Administration and Inspection," 1980.
6. Department of Conservation and Recreation, Commonwealth of Virginia, "Erosion and Sediment Control Regulations," 1990.
7. Department of Transportation, Federal Highway Administration, "Best Management Practices for Erosion and Sediment Control," 1978.
8. Division of Rural Resources, New Jersey Department of Agriculture, "Standards for Soil Erosion and Sediment Control in New Jersey," April 1987.
9. Duluth Technical College, Department of Civil Engineering, "Erosion Control Design," 1993-1994.
10. Environmental Protection Agency, "Guidance Manual for the Preparation of NPDES Permit Applications for Storm Water Discharge Associated with Industrial Activity," April 1991.
11. Environmental Protection Agency, "NPDES Storm Water Sampling Guidance Document," July 1992.
12. Environmental Protection Agency, "Sample Storm Water Pollution Prevention Plan for Construction Activities," September 1992.
13. Environmental Protection Agency, "Sample Storm Water Pollution Prevention Plan for Industrial Activities," September 1992.
14. Environmental Protection Agency, "Storm Water Management for Industrial Activities, developing pollution plans and best management practices," September 1992.
15. Environmental Protection Agency, "Storm Water Management for Construction Activities, developing pollution prevention plans and best management practices," September 1992.

## References

---

16. Georgia Stormwater Manual, <http://www.georgiastormwater.com>, 2005.
17. Georgia Soil and Water Conservation Commission, "Manual for Erosion and Sediment Control in Georgia," Second Edition 1990.
18. Geotechnical Fabrics Report, "A Bioengineering Approach to Upgrading Sediment Ponds," Volume 19, Number 1, January/February 2001.
19. Geotechnical Fabrics Report – Engineering Solutions for Roads, Soil, Water and Waste, Volume 21, Number 5, June/July 2003.
20. Geotechnical Fabrics Report – Engineering Solutions for Roads, Soil, Water and Waste, Volume 21, Number 6, August 2003.
21. Goldstein, N. "Constructed Wetlands for Erosion Control," *Erosion Control*, May/June 2001.
22. International Erosion Control Association, "IECA Report," Volume 25, Number 1, Summer 1993.
23. International Erosion Control Association, "Practical Approaches for Effective Erosion and Sediment Control," 1993.
24. Iowa Department of Natural Resources, "NPDES General Permit No. 2, Storm Water Discharge Associated with Industrial Activity for Construction Activities," October 1, 1992.
25. Iowa Department of Natural Resources, "Storm Water Management for Construction Activities," summary guidance, January 1993.
26. Iowa Department of Natural Resources, "Storm Water Management for Industrial Activities," summary guidance, February 1993.
27. Iowa Legislature, Code of Iowa, Chapter 161A44 to 161A51, "Soil and Water Conservation Practices," 1993.
28. Kansas City APWA, <http://www.kcapwa.net/>, 2002.
29. Lee, C. L.; Skogerboe; Eskew; Price; Page, et al, "Restoration of Problem Soil Materials at Corps of Engineers Construction Sites," May 1985.
30. Linn and Johnson County Soil Conservation Districts, Iowa State University Extension and Engineering Extension, "Soil and Water Engineering in Urbanizing Areas," February 13-14 1980.
31. Maryland Stormwater Design Manual, [http://www.mde.state.md.us/programs/waterprograms/sedimentandstormwater/stormwater\\_design/index.asp](http://www.mde.state.md.us/programs/waterprograms/sedimentandstormwater/stormwater_design/index.asp), 2002-2005.

32. National Cooperative Highway Research Report 221, Transportation Research Board, "Erosion Control During Highway Construction, Manual on Principles and Practices," April 1980.
33. North American Green, "Erosion Discussion," Volume 6, Issue 1, Summer 2001.
34. Ohio Department of Natural Resources, Division of Soil and Water Conservation, "Keeping Soil on Construction sites; Best Management Practices," March 1991.
35. Pioneer Technical Services Inc., "Montana Department of Transportation Highway Construction Standard Erosion Control Work Plan," March 1993.
36. Prepared by a committee of state and federal agencies involved in Soil and Water Conservation in New York. "Guidelines for Urban Erosion and Sediment Control," Third printing, October 1991.
37. State of Delaware, Division of Soil and Water Conservation, Department of Natural Resources and Environmental Control, "Sediment and Stormwater Regulations," November 1990.
38. Twin Cities (Metropolitan Council), <http://www.metrocouncil.org/environment/watershed/bmp/manual.htm>, 2003.
39. Virginia Department of Conservation and Recreation, Division of Soil and Water Conservation, <http://www.dcr.virginia.gov/sw/e&s.htm>, June 15, 2005.
40. Virginia Department of Conservation and Recreation, Division of Soil and Water Conservation, "Virginia Erosion and Sediment Control Handbook," Second Edition 1980.
41. Wischmeier, W. H. and Smith; D. D.; U.S. Department of Agriculture. Agriculture Handbook no. 537. "Predicting Rainfall Erosion Losses - A Guide to Conservation Planning," 1978.

# GLOSSARY

---

The following list is representative of terms used by various disciplines when working with construction sites and erosion and sediment control measures. The definitions have come from several sources; however, the majority originated in the Resource Conservation Glossary (Soil Conservation Society of America 1970).

**Aesthetics:** The appeal or beauty of objects, animals, plants, scenes, and natural or improved areas to the viewer and the appreciation for such items.

**Aggregate:** Crushed rock or gravel screened to different sizes for various uses in construction projects.

**Alluvium:** A general term for all material deposited or in transit by streams, including gravel, sand, silt, clay, and all variations and mixtures of these materials. Unless noted, alluvium is unconsolidated.

**Amendment:** Any material, such as lime, gypsum, sawdust, or synthetic conditioners that is worked into the soil to make it more productive. The term is used most commonly for added materials other than fertilizer.

**Angle of repose:** Angle between the horizontal and the maximum slope that soil assumes by natural process.

**Annual plant:** A plant that completes its life cycle and dies in one year or less.

**Apron:** A floor or lining to protect a surface from erosion.

**Aquifer:** A geologic formation or structure that transmits water in sufficient quantity to supply the needs for a water development; usually saturated sands, gravel, fractures, and cavernous rock. The term "water-bearing" is sometimes used synonymously with aquifer when a stratum furnished water for a special use.

**Available nutrient:** That portion of any element or compound in the soil that readily can be absorbed and assimilated by growing plants.

**Bedrock:** The solid rock underlying soils and in depths ranging from zero (where exposed by erosion) to several hundred feet.

**Berm:** An area that breaks the continuity of a slope.

**Borrow:** Surface excavated area. Material has been removed to facilitate construction.

**Bunchgrass:** A grass that does not have rhizomes or stolons and forms a bunch or tuft.

**Channel:** A natural stream that conveys water; a ditch or channel excavated for the flow of water.

**Channel stabilization:** Erosion prevention and stabilization of velocity distribution in a channel using jetties, drops, revetments, vegetation, and other measures.

**Clay (soils):** (1) A mineral soil separate consisting of particles less than 0.002 mm in equivalent diameter. (2) A soil textural class. (3) A fine-grained soil that has a high plasticity index in relation to the liquid limits.

**Clean Water Act (CWA):** The Federal Water Pollution Control Act.

**Clod:** A compact, coherent mass of soil ranging in size from 2 to 5 inches and much larger, produced artificially, usually by the activity by digging etc., especially when these operations are performed on soils that are either too wet or too dry for normal soil movement.

**Compaction:** The process by which the soil grains are rearranged to decrease the void space and bring the grains into closer contact with one another, and thereby increase the weight of solid material per cubic foot.

**Contour:** An imaginary line on the surface of the ground connecting points of the same elevation or a line drawn on a map connecting points of the same elevation.

**Cover:** (1) Vegetation or other material providing protection. (2) Ground and soils, any vegetation producing a protecting mat on or just above the soil surface. (3) Stream, generally trees, large shrubs, grasses and forbs that shade and otherwise protect the stream from erosion, temperature elevation or sloughing of banks. (4) Vegetation, all plants of all sizes and species found on an area, regardless of whether they have forage or other value. (5) Wildlife, plants, or objects used by wild animals for nesting, rearing of young, resting, escape from predators, or protection from adverse environmental conditions.

**Cover crop:** A close-growing crop grown primarily for the purpose of protecting and improving soil between periods of regular crop production.

**Critical area:** A severely eroded sediment-producing area that requires special management to establish and maintain vegetation in order to stabilize soil conditions.

**Cut:** Portion of land surface or area from which soil has been removed, or will be removed by excavation. The depth below original ground surface to excavated surface.

**Cut-and-fill:** Process of earth moving by excavating part of an area and using the excavated material for adjacent embankments or fill areas.

**Debris:** The loose material arising from the disintegration of rocks and vegetative material and transportable by streams, ice, or floods.

**Detention pond:** A structure built to divert part or all of the runoff water from a land area and to release the water under a controlled condition.

**Drainage:** The removal of excess surface water or ground water from land.

**Drainage, soil:** As a natural condition of the soil, soil drainage refers to the frequency and duration of periods when the soil is free of saturation. In well-drained soils, the water is removed

readily but not rapidly; in poorly drained soils, the root zone is waterlogged for long periods unless artificially drained, and the roots of ordinary crop plants cannot get oxygen. In excessively drained soils, the water is removed so completely that most crop plants suffer from lack of water. Excessively drained soils are a result of excessive runoff due to steep slopes or low available water holding capacity due to small amounts of silt, clay, and organic matter in the soil material.

**Ecology:** The study of interrelationships of organisms to one another and to their environment.

**Edge:** The transitional zone where one cover type ends and another begins.

**Environment:** The sum total of all external conditions that may act upon an organism or community to influence its development or existence.

**Erosion:** (1) The wearing away of the land surface by running water, wind, ice, or other geological agents, including such processes as gravitational creep. (2) Detachment and movement of soil or rock fragments by water, wind, ice, or gravity. The following terms are used to describe different types of water erosion.

**Accelerated erosion:** Erosion much more rapid than normal, natural, or geologic erosion, primarily as a result of the influence of the activities of man or in some cases, of other animals or natural KD that expose base surfaces, for example: fires or flooding.

**Rill erosion:** An erosion process in which numerous small channels only several inches deep are formed. This occurs mainly on recently tilled soil.

**Sheet erosion:** The removal of a fairly uniform layer of soil from the land surface by runoff water.

**Essential element (plant nutrition):** A chemical element required for the normal growth and reproduction of plants.

**Exposure:** Direction of slope with respect to points of a compass.

**Fertility (soil):** The quality of a soil that enables it to provide nutrients in adequate amounts and in proper balance for the growth of specified plants when other growth factors, such as light, moisture, temperature, and the physical condition of the soil, are favorable.

**Filter strip:** Strip of permanent vegetation above ponds, diversion terraces and other structures to retard flow of runoff water and thereby reduce sediment flow.

**Final Stabilization:** Period when all soil disturbing activities at the site have been completed, and a uniform perennial vegetative cover with a density of 70% for the area has been established or equivalent stabilization measures have been employed.

**Flora:** The sum total of the kinds of plants in an area at one time.

**Forb:** An herbaceous plant which is not a grass, sedge, or rush.

**Forest:** A plant association predominantly of trees and other woody vegetation.

**fps:** Abbreviation for feet per second.

**Gabion:** A rectangular or cylindrical wire mesh cage filled with rock and used as a protecting apron, revetment, retaining wall, etc., against erosion.

**General Permit:** An NPDES permit issued under 40 CFR 122.28 that authorizes a category of discharges under the CWA within a geographical area. A general permit is not specifically tailored for an individual discharge.

**Grade:** (1) The slope of a road, channel or natural ground or any surface prepared for the support of construction like paving. (2) To finish the surface of a roadbed, top of embankment, or bottom of excavation.

**Gradient:** A measure of the earth surface slope relating changes in horizontal distance to changes in vertical elevation.

**Grass:** A member of the botanical family Gramineae, characterized by bladelike leaves arranged on the culm or stem in two ranks.

**Grassed Channel (waterway):** A natural or constructed waterway, usually broad and shallow, covered with erosion resistant grasses, used to conduct surface water from land.

**Ground cover:** Grasses or other plants grown to keep soil from being blown or washed away.

**Ground water:** Subsurface water in the zone of saturation.

**Gully:** A channel or miniature valley cut by concentrated runoff but through which water commonly flows only during and immediately after heavy rains or during the melting of snow. The gullies may be branching or linear, rather long, narrow, and of uniform width. The difference between gully and rill is the depth. A gully is sufficiently deep that it would not be obliterated by tillage operations. A rill of lesser depth can be smoothed by regular tillage equipment.

**Heaving:** The partial lifting of plants out of the ground, frequently breaking their roots as a result of freezing and thawing of the surface soil during winter. Structures built on top of the ground may also heave and become misaligned.

**Heavy metals:** Metals that may be present in industrial wastes that pose long-term environmental hazards. These include cadmium, cobalt, chromium, copper, mercury, nickel, lead and zinc.

**Impervious soil:** A soil through which water, air, or roots cannot penetrate. No soil is impervious to water and air all the time.

**Infiltration:** The gradual downward flow of water from the surface through soil to ground water and water table reservoirs.

**Interceptor drain:** Surface or subsurface drain, or a combination of both, designed and installed to intercept flowing water.

**Interseeding:** Seeding into established vegetation.

**Land capability:** The suitability of land for use without permanent damage. The risks of land damage from erosion and the difficulties in land use because of the physical land characteristics.

**Legume:** A member of the Leguminosae family, one of the most important and widely distributed plant families. Leaves are alternate, have stipules and are usually compound. Most legumes are nitrogen-fixing plants.

**Legume inoculation:** The addition of nitrogen-fixing bacteria to legume seed or to the soil in which the seed is to be planted.

**Loess:** Soil material transported and deposited by wind and consisting of predominantly silt-sized particles.

**Map, topographic:** A representation of the physical features of a portion of the earth's surface as a plane surface, on which terrain relief is shown by a system of lines, each representing a constant elevation above a datum or reference plane.

**Marsh:** A periodically wet or continually flooded area where the surface is not deeply submerged; covered predominantly with sedges, cattails, rushes, or other hydrophytic plants.

**Mineral soil:** A soil consisting predominantly of, and having its properties determined by, mineral matter usually containing less than 20% organic matter, but sometimes containing an organic surface layer up to 30 cm thick.

**Mulch:** A natural or artificial layer of plant residue or other materials, such as sawdust, straw, leaves, bark, sand, or gravel, on the soil surface to protect the soil and plant roots from the effects of raindrops, soil crusting, freezing, evaporation, etc.

**Natural revegetation:** Natural re-establishment of plants; propagation of new plants over an area by natural processes.

**Niche:** A habitat that supplies the factors necessary for the existence of an organism or species.

**Nitrogen-fixing plant:** A plant that can assimilate and fix the free nitrogen of the atmosphere with the aid of bacteria living in the root nodules. Legumes with the associated rhizobium bacteria in the root nodules are the most important nitrogen-fixing plants.

**NPDES:** National Pollutant Discharge Elimination System.

**Nurse Crop:** Seeding of a short-life crop with a permanent species to aid in erosion control until the permanent species are established.

**Nutrients:** Elements or compounds, essential as raw materials for organism growth and development, such as carbon, oxygen, nitrogen, and phosphorus.

**Organic matter:** Decomposition products of plant and animal materials such as litter, leaves, and manure.

**Organic soil:** A soil that contains a high percentage, 20% to 30%, of organic matter throughout the soil mixture.



**Perennial plant:** A plant that normally lives three or more years.

**Permeability, soil:** The quality of a soil horizon that enables water or air to move through it. The permeability of a soil may be limited by the presence of one nearly impermeable horizon even though the others are permeable.

**pH:** The measure of hydrogen. Neutral is pH 7.0. All pH values below 7.0 are acidic, and all above 7.0 are alkaline.

**Planting season:** The period of the year when planting or transplanting is considered advisable from the standpoint of successful establishment.

**Rehabilitation:** Implies that the land will be returned to a form and productivity in conformity with a prior land use including a stable ecological state that does not contribute substantially to environmental deterioration and is consistent with surrounding aesthetic values.

**Revegetation:** Plants or growth that replaces original ground cover following land disturbance.

**Revetment:** Facing of stone or other material, either permanent or temporary, placed along the edge of a stream to stabilize the bank, and to protect it from the erosive action of the stream.

**Riparian land:** Land situated along the bank of a stream or other body of water.

**Ripper:** Any implement such as a subsoiler, chisel plow, or ripper used to break apart compacted soil layers below the normal 6 inch depth.

**Riprap:** Broken rock, cobbles, or boulders placed on earth surfaces, such as the face of a dam or the bank of a stream, for protection against the action of water or waves.

**Root zone:** The part of the soil that is penetrated, or can be penetrated, by plant roots.

**Runoff (hydraulics):** That portion of the precipitation on a drainage area that is discharged from the area. Types include surface runoff and ground water runoff (seepage).

**Sand lens:** Lenticular band of sand in sedimentary banded material.

**Section (401)(a) Certification:** A requirement of Section 401(a) of the Clean Water Act that all federally issued permits be certified by the state in which the discharge occurs. The state certifies that the proposed permit will comply with state water quality standards and other state requirements.

**Sediment:** Solid material, both mineral and organic, that is in suspension, is being transported, or has been moved from its site of origin by air, water, gravity, or ice, and has come to rest on the earth's surface, either above or below sea level.

**Seed:** The fertilized and ripened ovule of a seed plant that is capable, under suitable conditions, of independently developing into a plant similar to the one that produced it. Types of seeds include:

**Certified seed:** The progeny of foundation or registered seed that is so handled as to maintain satisfactory genetic identity and purity and that has been approved and certified by the certifying agency.

**Commercial seed:** A term used to designate other than recognized varieties of seed in commercial trade.

**Dormant seed:** An internal condition of the chemistry or stage of development of a viable seed that prevents its germination, although good growing temperatures and moisture are provided.

**Firm seed:** Dormant seeds, other than hard seeds, that neither germinate nor decay during the prescribed test period under the prescribed conditions. Firm, ungerminated seeds may be alive or dead.

**Hard seed:** A physiological condition of seed in which some seeds do not absorb water or oxygen and germinate when a favorable environment is provided.

**Seedbed:** The soil prepared by natural or artificial means to promote the germination of seed and the growth of seedlings.

**Seeding, direct:** In broadcast seeding, seed is sown over the entire area. Partial seeding may be done in strips, furrow rows, surface roughened area, or for spot seeding.

**Seed purity:** The percentage of the desired species in relation to the total quantity of other species, weed seeds, and foreign matter.

**Seepage:** Water escaping through, or emerging from, the ground along an extensive line or surface, as contrasted with a spring where the water emerges from a localized spot.

**Shale:** Sedimentary or stratified rock structure generally formed by the consolidation of clay or claylike material.

**Shrub:** A woody perennial plant differing from a tree by its low stature and generally producing several basal shoots.

**Sod:** A closely-knit ground cover growth, primarily of grasses.

**Soil conditioning:** Those essential treatment measures of a physical, chemical, and/or biological nature that are applied to critical areas 1 to 6 months in advance of the establishment of vegetation.

**Soil horizon:** A layer of soil, approximately parallel to the soil surface, with distinct characteristics produced by soil-forming processes.

**Soil material:** Any drastically disturbed portion of the earth's surface that could consist of one or more of the soil horizons.

**Soil structure:** The combination or arrangement of primary soil particles into secondary particles or units. The secondary particles are classified on the basis of size, shape, and degree of distinctness into classes, types, and grades.

**Soil survey:** A general term for the examination of soils in the field and laboratories. This includes the mapping of different kinds of soils. The adaptability of the different kinds of soil is also noted.

**Soil texture:** Soil texture class names of soil are based on the relative percentages of sand, silt, and clay.

**Stubble:** The basal portion of plants remaining after the top portion has been harvested.

**Subsoil:** In soils with weak profile development, the subsoil can be defined as the soil below the normal tilled area.

**Subsoiling:** The tillage of subsurface soil for the purpose of breaking up dense layers that restrict water movement and root penetration.

**Surface water:** All water whose surface is exposed to the atmosphere.

**Tacking:** The process of binding mulch fibers together by the addition of a sprayed chemical compound.

**Terrace:** An embankment or combination of an embankment and channel, constructed across a slope to control erosion by diverting surface water.

**Tile drain:** Designed to carry excess water from the soil.

**Topsoil:** The unconsolidated earthy material that exists in its natural state and is or can be made favorable to the growth of desirable vegetation. Usually the A-horizon of soils with developed profiles.

**Vegetation:** Plants in general, or the sum total of plant life in an area.

**Wasted:** Excess soil deposits resulting from construction.

**Watershed area:** All land and water within the confines of a drainage divide, or a water problem area consisting in whole or in part of land needing drainage.

**Weed:** An undesired uncultivated plant.

**Xerophyte:** A plant capable of surviving periods of prolonged moisture deficiency.